

SATIŞ KATALOĞU  
2017



MAKE IT WONDERFUL

**FRANKE**

It's easy to be **ORDINARY**.  
**OK TO BE OK.** But For Franke.

BEING JUST GOOD IS

**NOT GOOD ENOUGH.**

instead, we ask: **'HOW CAN WE MAKE IT**

**WONDERFUL?'**

wonderful takes the Everyday

AND MAKES IT  
SOMETHING

**SPECIAL.**

*Wonderful design,*

*Wonderful quality, Wonderful service.*

IT INSPIRES

CUSTOMERS TO

**CREATE,**

which in turn creates *happy customers:*

SO LET'S LET  
EVERYONE ELSE BE

**ORDINARY.**

while we...





# MAKE IT WONDERFUL





## EVİNİZ İÇİN MÜKEMMEL ÇÖZÜMLER

Tasarımımızın temelini oluşturan sistem anlayışı paralelinde, müşterilerimizin mutfaklarında ihtiyaç duyacakları tüm hizmetleri tek bir marka şemsiyesi altında her aşamada çözüm sağlamak.

Geniş malzeme alternatifli evyeler, tasarımları ile onları tamamlayan armatürler, performans ve özgünlüğün birleştiği davlumbaz, ocak, fırın, mikrodalga ve tüm ankastrer cihazlar mutfağı sadece yemek pişirilebilen bir alandan çıkarıp, günlük hayatın içine yerleştiren bir alan olması için sadece bir başlangıçtır. “Mutfakı mükemmel hale getirmede bize ilham veren de budur.”

“Make it Wonderful”

2017 yeni Franke ürün gamını keşfetmeniz için kataloğumuz size yardımcı olacaktır.

-  [www.franke.com.tr](http://www.franke.com.tr)
-  [facebook.com/franketr](https://facebook.com/franketr)
-  [instagram.com/franke\\_tr](https://instagram.com/franke_tr)
-  [youtube.com/Franke Türkiye](https://youtube.com/Franke_Turkiye)

### İçindekiler

Çelik / Renkli Evyeler	12-85
Armatürler	86-111
WS Banyo Armatürleri & Aksesuarlar	112-139
Ocaklar	140-167
Fırın ve Mikrodalgalar	168-197
Davlumbazlar	198-233
Yıkama Grubu	234-243
Buzdolapları	244-251
Çöp öğütücü ve aksesuarlar	252-255
Franke Yüzey Uygulamaları	256-271

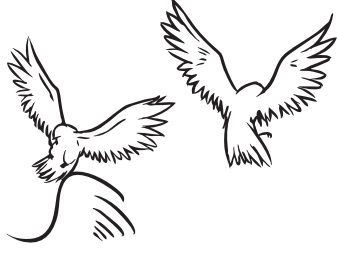

1911 yılında İsviçre’de kurulan Franke bugün;

- ✓ 5 kıtaya yayılmış
  - ✓ 40 ülkede
  - ✓ 70 firmasında
  - ✓ 10.000 üzerinde çalışan
- sayısına sahip bir ailedir.

100 YILI AŞKIN  
BİR SERÜVEN

Franke hikayesi, 1911’de Hermann Franke tarafından İsviçre’nin Rorschach kentinde küçük bir saç metal atölyesi olarak başladı.

Geçtiğimiz yüzyılda birçok şey değişti ancak her zaman aynı olan saygı, güven ve açıklıkla karakterize edilen değerler; yenilik, girişimcilik, kalite ve şık tasarım ile Franke’nin kalbinde yer aldı.

Akıllı ve çarpıcı tasarımlar ile de işin kalbinde yer almaya devam ediyor.

FRANKE TÜRKİYE

1999 yılında Kartal’da faaliyetlerine başlayan ve 2000 yılına kadar sadece eviye, armatür ile faaliyet gösteren Franke Türkiye, bugün Mutfak Sistemleri ürün grubu içerisinde Solid Surface akrilik tezgahları, tüm ankastre mutfak cihazları, paslanmaz çelik banyo malzemeleri ürün grubu ile kendi sektöründe Türkiye’nin en geniş ürün gamına sahip firmasıdır.

Make  
it  
Wonderful

# FRANKE GRUP



## Franke Mutfak Sistemleri



Mutfak için her zaman akıllı sistemler, estetik çözümler sunan Franke, geliştirdiği Sistem Konseptleri ile birbirine uyumlu ürünlerden oluşan eviye, armatür ve ankastre cihazlar sunar.

## Paslanmaz Çelik Sıvı İçecek Tankları



Franke Grup bu alanda geliştirdiği teknolojilerle uluslararası pek çok markanın sağlayıcısı konumundadır.

## Franke Endüstriyel Mutfak Sistemleri



Franke grup tüm aksesuarlar dahil olmak üzere hızlı optimizasyon ve profesyonel çözümlerle dünyanın en büyük fast food zincirlerine hizmet vermektedir.

## Paslanmaz Çelik Banyo Malzemeleri



Paslanmaz Çelik Banyo Malzemelerinde dünya liderlerinden olan Franke grup; Avm, hotel, havaalanı, stadyum, hapishane, okul, hastane ve laboratuvar gibi pek çok halka açık kullanım alanı wc'lerinde yüksek güvenlik ve hijyen önceliği olan her alanda hizmet verir.

## Profesyonel Kahve Sistemleri



Franke kahve sistemleri eşsiz teknolojilerle sahip makineleri ile dünyanın en büyük kahve makinesi üreticilerindedir.

# FRANKE İNOVASYON TEKNOLOJİLERİNDEN SİZİN İÇİN SEÇTİKLERİMİZ



## ■ Greenline Teknolojisi

Brushless motor ile standart davlumbaz motorlarına göre %85'e varan enerji tasarrufu sağlar.



## ■ Anti-Condensation Sistem

Davlumbazın çekiş yüzeyi cam olarak tasarlanmıştır. Bu estetik detay, pişirme sırasında davlumbazın cam yüzeyinde oluşan su damlacıklarının hızlı kurumasını sağlayan özel bir teknolojiye sahiptir.



## ■ Esnek Çelik Süzgeç

Modele göre Franke eviyelere dahil yada opsiyonel olarak sunulan Frankenin geliştirdiği ergonomik rulo şeklindeki süzgeç haznelerde, damlalıklarda sebze, meyve yada mutfak gereçlerini kurutmak için estetik bir çözüm sunar.



## ■ Sifon Kumandası

Hazneye elinizi sokmadan birikmiş suyu tahliye etmek ya da hazneye su biriktirmek için kullanılan sifon kumandası alçak boyu sayesinde kolu yanda olan armatürlerin yanında da kullanılabilir.



## ■ Üç farklı montaj seçeneği aynı evyede birleşti

Tezgah altı, tezgah üstü veya tezgaha "0" olarak üç farklı kullanım imkanı sunan Box serisi eviyeler üç farklı tezgah uygulama özelliğini bir arada bulundurarak tezgaha uygun estetik sağlar.



## ■ Sanitized Hijyen Foksiyonu

Yüzeyde oluşabilecek bakterileri %99 oranında yok eden Sanitized hijyen fonksiyonu sadece Franke Granit Eviyelerde mevcuttur.



## ■ DuraKleen®

Franke granit eviyelerin tamamının üretim aşamasında kullanılan granit partiküller olabileceği en küçük seviyededir. Bu sayede yüzeyleri daha pürüzsüz temizliği daha kolay ve sıvı emmeyen yapısı ile daha hijyeniktir.



## ■ DCT, Devrimci Teknoloji



DCT teknolojisi 1 kW'lık güç ile herhangi bir türdeki yemeğin pişmesine olanak sağlar. Bu şekilde 3 kW'lık mevcut güç içinde kalarak birden fazla elektrikli alet aynı anda kullanılabilir, ayrıca alternatif ve yenilenebilir kaynaklardan elde edilen enerjiden tam anlamıyla yararlanılır.

Franke DCT Fırınlar, A++ enerji sınıfına sahip tek ürünlerdir. Avrupa standartlarına göre bu enerji performansı en yüksek sınıflandırmadır.



## ■ Patentli Klips Sistemi

Modele göre sökülebilir cam iç kapağı bulunan fırınlarda Franke patentli klips sistemi ile iç cam kolaylıkla çıkarılabilir ve temizlenip geri takılabilir.



## ■ Yüksek etkinliğe sahip yeni Flat yakıcılar

Çekici bir estetikle birleşen Flat yakıcılar doğrudan tencere üzerine yönlendirilmiş dikey alev sayesinde çok yüksek etkinlikte performans ve belirgin enerji tasarrufunu garanti eder.





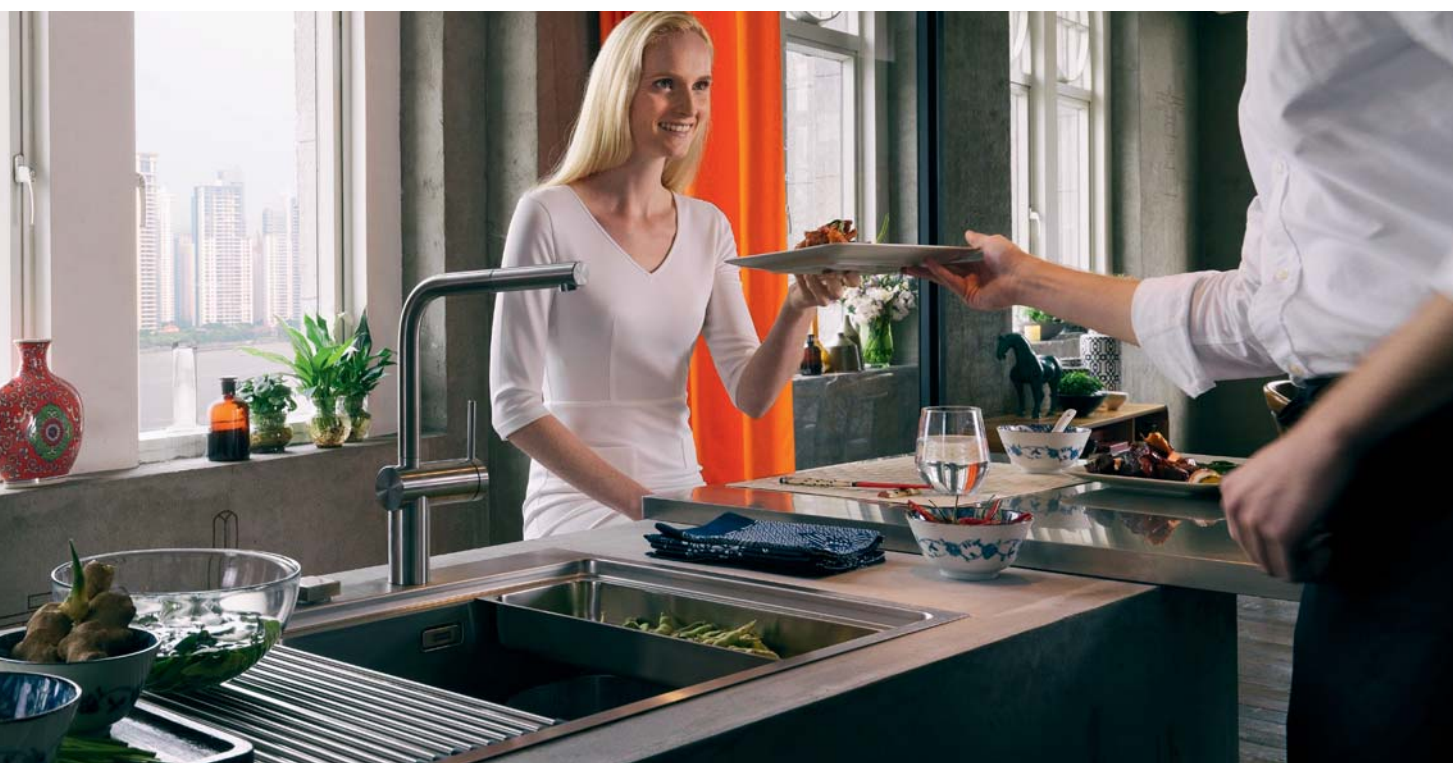





# EVIYELER

---





Make  
it  
Wonderful

# FRANKE EVİYENİ SEÇ

Kullanım alışkanlıkları, mutfak tasarımı yada renklere uygun Franke eviyeyi seçmek için hazne genişliği, malzeme alternatifi, aksesuar gibi detaylar bu seçim aşamasında önemli bir noktadır. Franke ürün gamında ultra-modernden klasik tasarıma kadar pek çok eviye modeli bulunur. Size en uygun Franke eviyeyi seçerken tasarımın yanında sağlayacağı avantajları da unutmamak gerekir.

## ■ Montaj tipine göre eviye seçimi



Tezgahaltı



Alttan monteli Franke eviyeler tasarım olarak gizli bir estetik sunarken eviye kenarlarına su yada kir birikmemesi için eviyenin hijyen özelliğini ön plana çıkarır. Sadece yuvarlak hatlara sahip eviyeler değil, kare ve modern tasarımlı tezgahaltı eviyelerde Franke ürün gamında alternatif sunmaktadır.



Tezgah üstü



Klasik bir şekilde tezgahlara üstten monte edilen ince kenarlara sahip Franke tezgahüstü eviyeler geniş bir model alternatifine sahiptir. Damlalıklı yada damlalıksız modeller fonksiyonel aksesuarlarla birleşerek tasarımlarını tamamlar.

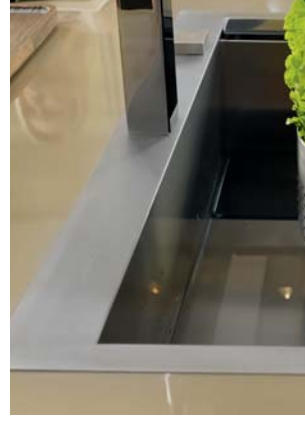

Slimtop



Hem tezgah üstü hemde tezgaha "0" olarak kullanım imkanı sağlayan Slimtop kenar özelliği montaj aşamasında kolaylık sağlarken, ince kenarlar estetik bir duruş katıyor. İnce kenar avantajı kir birikimini engelleyerek hijyen özelliğininde ön plana çıkarıyor.



Tezgaha sıfır



Eviye kenarının tezgah ile aynı seviyede olduğu bu montaj tipi Slimtop tasarıma oldukça benzer. Tezgah ve eviye kenarı aynı yükseklikte birleşerek pürüzsüz bir kullanım yaratır. Modern mutfakların en çok tercih edilen montaj uygulamalarından biridir.

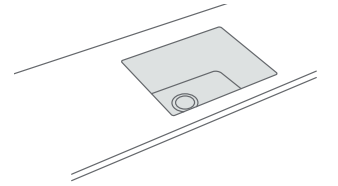
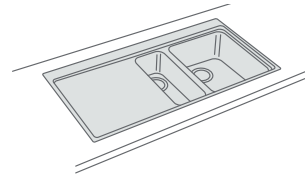
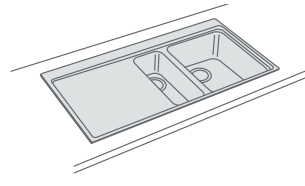
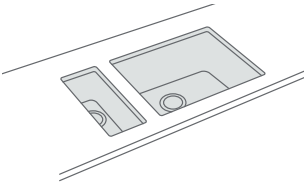

## ■ Alt dolap ölçüsü ve hazne genişliği

Modele göre Franke eviyelerde tasarım olarak hazneler farklı genişlik ve derinlikte alternatiflere sahiptir. Alt dolap ölçüsü de buna bağlı olarak belirlenir. Tezgaha ve mutfuğa uygun eviyeyi seçmek için katalogdaki teknik çizimler yol göstericidir. Geniş hazneler büyük kapları yıkamada kolaylık sağlarken derinlikler suyun sıçramasını engelleyecektir.



## ■ Fonksiyonel Aksesuarlar (Opsiyonel ya da eviyeye dahil)

ACCES-  
SORIES

Haznelere uygun yarım süzgeçler, kurutma için kullanılan çelik esnek süzgeçler, estetik doğrama aksesuarları eviyeleri fonksiyon ve tasarım olarak tamamlayan iş ortaklarıdır. Modele göre eviyeze uygun aksesuarı görmek için ürünün ilgili katalog sayfasına göz atmak yeterlidir.



## ■ Çöp öğütücüsü kullanımına uygun giderler

Franke eviyelerde bulunan 3<sup>1/2</sup> inç. gider alternatifi sayesinde çöp öğütücüsüne uygun kullanım sağlanmaktadır. Tüm evsel atıklar bu sayede eviye kullanımı ile birleşerek mutfakta kullanım kolaylığı sunar.





## ■ Sifon kumandası

Sifon kumandası sayesinde elinizi hiç ıslatmadan hazne içine su doldurabilir, yada dolan suyu boşaltabilirsiniz. Alçak boyu sayesinde kolu yanda olan armatürlerin yanında bile kullanılabilir. Modele göre pop - up ya da döner başlı sifon kumandaları Franke eviyelerin fonksiyonel özelliklerinden biridir.



Opsiyonel / döner başlı sifon kumandası.



Pop - up sifon kumandası.



Eviyeye dahil / döner başlı sifon kumandası.



## ■ Eviyeye monte sızdırmazlık contası



Eviyeye üretim anında monte edilen bu sızdırmazlık contası hem montaj aşamasında kolaylık sağlar, hem de montaj sonrası estetiği korur.



## ■ Hazne içi estetik su gideri

Estetik olarak hazne içlerinde gizli bir fonksiyon olarak konumlanan giderler sayesinde fazla su akması durumunda suyun haznenin dışına taşması önlenir.

## ■ Damlalık gideri



Franke eviyelerde bulunan damlalık giderleri sayesinde su kolaylıkla tahliye edilir ve damlalık kuru kalır.



## ■ Malzeme, renk ve yüzey



### Paslanmaz Çelik

AISI  
304

Inox, dekor, mikrodekor gibi yüzey alternatifleri bulunan paslanmaz çelik eviyeler 304 kalite paslanmaz çelikten üretilmiş malzemeleri çeliğin esnek yapısından faydalanan zarif tasarımları ve hijyenik kullanımları ile tüm mutfak tipleri için modern çözümler sunar.

Dekor ve mikrodekor yüzey alternatifleri çizikleri kamufle ederek su lekelerininide daha az gösterir.



### Granit

Franke granit eviyeler avena, sahara, bianco, grafite, black ve white gibi renk seçenekleri ile mutfaklarda soft ve doğal bir görünüm yansıtıyor.

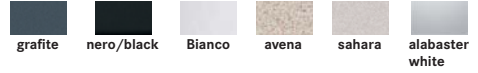

### Tectonite

Su tutmayan pürüzsüz yüzeyleri ani ısı değişimi ve darbelere dayanıklı yapısı ile granit eviyelere alternatif olan tectonite eviyeler avena, bianco, grafite renkleri ve sade hatları ile renkli eviye seçeneklerinde sirius serisi ile yer alır.

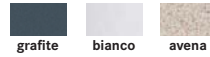

### Cam

Zarif görüntüsünün aksine darbelere oldukça dayanıklı cam yüzeyleri paslanmaz çelik haznelere birleşen Franke cam eviyeler matlaştırılmış damlalıkları sayesinde çizige de son derece dayanıklıdır.







# TEZGAHALTI EVIYELER

COLIBRI	20
BACCINI	20-21
BOX	22-23
PLANAR	24
PEAK	25



## Çelik Tel Sepet

112.0047.840  
340x400 mmAMX 110-34 / AMX 160 / AMX 120  
modelleri ile uyumludur.  
opsiyoneldir.

Tüm Baccini tezgahaltı serisi eviyeler üzerinde armatür deliği bulunmamaktadır.  
Armatür tezgaha monte edilebilir.

## Colibri

CIN 00-40  
CIL 00-40Inox   
Dekor 122.0368.992  
122.0368.995Montaj tipi  
Ebat  
Birlikte verilen bağlantı  
Alt Dolap ölçüsüTezgah Altı  
430 x 430 mm  
112.0369.660 sifon  
Minimum 45 cm

## Baccini

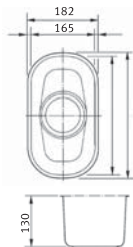

AMX 110-16

Inox

122.0018.093

Montaj tipi  
Ebat  
Birlikte verilen bağlantı  
Alt Dolap ölçüsüTezgah Altı  
188 X 323 mm  
112.0059.982, sifon 112.0068.243  
Minimum 30 cm

## Baccini

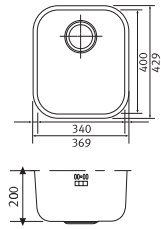

**AMX 110-34**

**Inox**

**122.0021.444**

**Montaj tipi**  
**Ebat**  
**Birlikte verilen bağlantı**  
**Alt Dolap ölçüsü**

Tezgah Altı  
369 x 429 mm  
112.0059.982, sifon 112.0068.243  
Minimum 45 cm



## Baccini

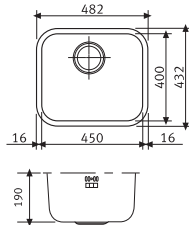

**GAX 110-45**

**Inox**

**122.0021.440**

**Montaj tipi**  
**Ebat**  
**Birlikte verilen bağlantı**  
**Alt Dolap ölçüsü**

Tezgah Altı  
482 x 432 mm  
112.0059.982, sifon 112.0068.243  
Minimum 60 cm



## Baccini

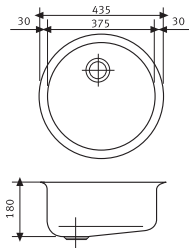

**RBX 110**

**Inox**

**122.0060.328**

**Montaj tipi**  
**Ebat**  
**Birlikte verilen bağlantı**  
**Alt Dolap ölçüsü**

Tezgah Altı  
Ø435  
112.0059.982, sifon 112.0068.243  
Minimum 60 cm



## Baccini

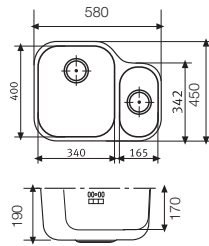

**AMX 160**

**Inox**

**122.0021.448**

**Montaj tipi**  
**Ebat**  
**Birlikte verilen bağlantı**  
**Alt Dolap ölçüsü**

Tezgah Altı  
580 x 450mm  
112.0059.989, 112.0048.209  
Minimum 60 cm



## Baccini

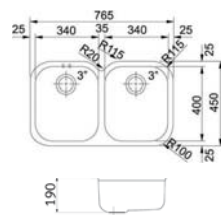

**AMX 120**

**Inox**

**122.0021.446**

**Montaj tipi**  
**Ebat**  
**Birlikte verilen bağlantı**  
**Alt Dolap ölçüsü**

Tezgah Altı  
765 x 450 mm  
112.0059.989, sifon 112.0068.244  
Minimum 80 cm



## Baccini

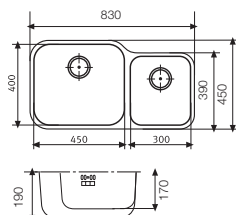

**GAX 120**

**Inox**

**122.0021.447**

**Montaj tipi**  
**Ebat**  
**Birlikte verilen bağlantı**  
**Alt Dolap ölçüsü**

Tezgah Altı  
830 x 450 mm  
112.0059.989, 112.0068.244  
Minimum 90 cm



Tezgahaltı, Tezgahüstü veya Tezgaha '0' olarak 3 farklı kullanım imkanı



Tüm Box serisi eviyeler üzerinde armatür deliği bulunmamaktadır. Armatür tezgaha monte edilebilir.

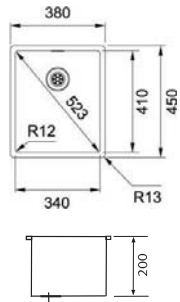

AISI  
304



**BXX 210/110-34**

**Inox**

**127.0369.056**

**Montaj tipi**  
**Ebat**  
**Montaj ölçüsü**  
**Birlikte verilen bağlantı**

Tezgah Altı, Tezgah Üstü yada Tezgaha Sıfır  
380 x 450 mm  
Kutuların içinde şablon mevcuttur  
112.0049.409 - 133.0254.554  
sifon 112.0048.206, klips 133.0172.567  
Minimum 45 cm

**Alt Dolap ölçüsü**

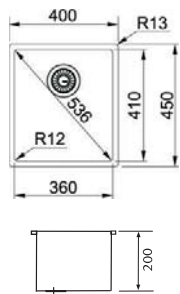

AISI  
304



**BXX 210/110-36**

**Inox**

**127.0369.913**

**Montaj tipi**  
**Ebat**  
**Montaj ölçüsü**  
**Birlikte verilen bağlantı**

Tezgah Altı, Tezgah Üstü yada Tezgaha Sıfır  
400 x 450 mm  
Kutuların içinde şablon mevcuttur  
112.0049.409 - 133.0254.554  
sifon 112.0048.206, klips 133.0172.567  
Minimum 45 cm

**Alt Dolap ölçüsü**

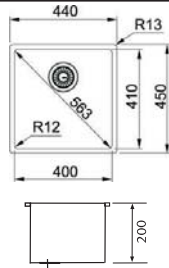
**BXX 210/110-40****Inox****127.0369.215**

Montaj tipi  
Ebat  
Montaj ölçüsü  
Birlikte verilen bağlantı  
Alt Dolap ölçüsü

Tezgah Altı, Tezgah Üstü yada Tezgaha Sıfır  
440 x 450 mm  
Kutuların içinde şablon mevcuttur  
112.0049.409 - 133.0254.554  
sifon 112.0048.206, klips 133.0172.567  
Minimum 50 cm

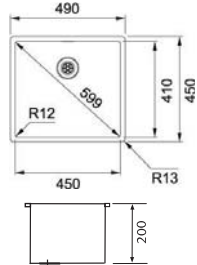
**BXX 210/110-45****Inox****127.0369.250**

Montaj tipi  
Ebat  
Montaj ölçüsü  
Birlikte verilen bağlantı  
Alt Dolap ölçüsü

Tezgah Altı, Tezgah Üstü yada Tezgaha Sıfır  
490 x 450 mm  
Kutuların içinde şablon mevcuttur  
112.0049.409 - 133.0254.554  
sifon 112.0048.206, klips 133.0172.567  
Minimum 55 cm

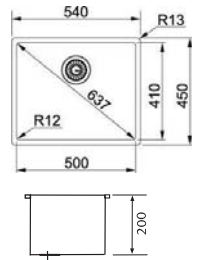
**BXX 210/110-50****Inox****127.0369.282**

Montaj tipi  
Ebat  
Montaj ölçüsü  
Birlikte verilen bağlantı  
Alt Dolap ölçüsü

Tezgah Altı, Tezgah Üstü yada Tezgaha Sıfır  
540 x 450 mm  
Kutuların içinde şablon mevcuttur  
112.0049.409 - 133.0254.554  
sifon 112.0048.206, klips 133.0172.567  
Minimum 60 cm

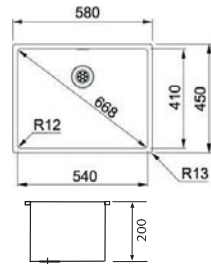
**BXX 210/110-54****Inox****127.0371.513**

Montaj tipi  
Ebat  
Montaj ölçüsü  
Birlikte verilen bağlantı  
Alt Dolap ölçüsü

Tezgah Altı, Tezgah Üstü yada Tezgaha Sıfır  
580 x 450 mm  
Kutuların içinde şablon mevcuttur  
112.0049.409 - 133.0254.554  
sifon 112.0048.206, klips 133.0172.567  
Minimum 80 cm

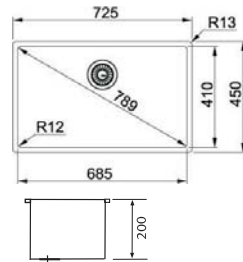
**BXX 210/110-68****Inox****127.0369.284**

Montaj tipi  
Ebat  
Montaj ölçüsü  
Birlikte verilen bağlantı  
Alt Dolap ölçüsü

Tezgah Altı, Tezgah Üstü yada Tezgaha Sıfır  
725 x 450 mm  
Kutuların içinde şablon mevcuttur  
112.0049.409 - 133.0254.554  
sifon 112.0048.206, klips 133.0172.567  
Minimum 80 cm

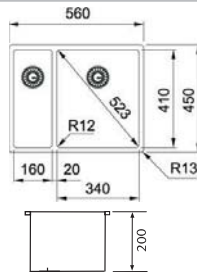
**BXX 260/160 34-16****Inox****127.0369.916**

Montaj tipi  
Ebat  
Montaj ölçüsü  
Birlikte verilen bağlantı  
Alt Dolap ölçüsü

Tezgah Altı, Tezgah Üstü yada Tezgaha Sıfır  
560 x 450 mm  
Kutuların içinde şablon mevcuttur  
133.0254.554 - 133.0254.556  
112.0049.409 sifon 112.0048.209,  
klips 133.0172.567  
Minimum 60 cm

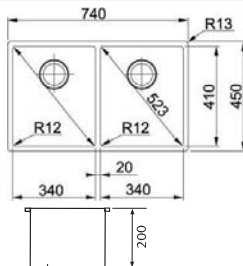
**BXX 220/120 34-34****Inox****127.0370.188**

Montaj tipi  
Ebat  
Montaj ölçüsü  
Birlikte verilen bağlantı  
Alt Dolap ölçüsü

Tezgah Altı, Tezgah Üstü yada Tezgaha Sıfır  
740 x 450 mm  
Kutuların içinde şablon mevcuttur  
112.0049.409 - 133.0254.554  
sifon 112.0048.209, klips 133.0172.567  
Minimum 80 cm





## Çelik Yarım Hazne Süzgeci

112.0042.960



PPX 110-38 / PPX 110-52 / PPX 120  
modelleri ile uyumludur.  
**opsiyoneldir**

Tüm Planar tezgahaltı serisi eviyeler üzerinde armatür deliği bulunmamaktadır.  
Armatür tezgaha monte edilebilir.

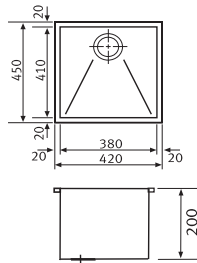

PPX 110-38

Inox

122.0203.472

Montaj tipi  
Ebat  
Birlikte verilen bağlantı  
Alt Dolap ölçüsü

Tezgah Altı,  
380 x 410 mm  
112.0059.978, sifon 112.0068.243  
Minimum 60 cm

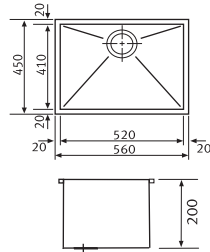

PPX 110-52

Inox

122.0203.471

Montaj tipi  
Ebat  
Birlikte verilen bağlantı  
Alt Dolap ölçüsü

Tezgah Altı  
520 x 410 mm  
112.0059.978, sifon 112.0068.243  
Minimum 80 cm

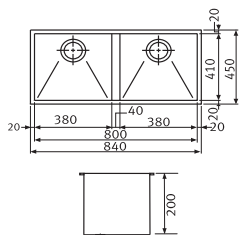

PPX 120

Inox

122.0198.205

Montaj tipi  
Ebat  
Birlikte verilen bağlantı  
Alt Dolap ölçüsü

Tezgah Altı  
800 x 410 mm  
112.0068.694, sifon 112.0068.244  
Minimum 90 cm



### Çelik Yarım Hazne Süzgeci

112.0066.060  
156x439x54 mm

PKX 110-45 / PKX 110-70  
modelleri ile uyumludur.

opsiyoneldir



Çelik / Renkli  
Eviyeler

Tüm Peak tezgahaltı serisi eviyeler üzerinde armatür deliği bulunmamaktadır.  
Armatür tezgaha monte edilebilir.

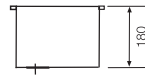
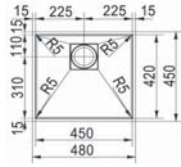

PKX 110-45

Inox



122.0157.731

Montaj tipi

Tezgah Altı

Ebat

450 x 420 mm

Birlikte verilen bağlantı

112.0048.520-133.0173.094-112.0169.254

133.0175.505-133.0085.915

sifon 112.0068.243

Alt Dolap ölçüsü

Minimum 60 cm

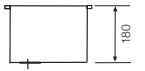
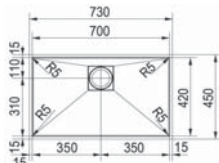

PKX 110-70

Inox



122.0157.741

Montaj tipi

Tezgah Altı

Ebat

700 x 420 mm

Birlikte verilen bağlantı

112.0048.520-133.0173.094-112.0169.254

133.0175.505-133.0085.915

sifon 112.0068.243

Alt Dolap ölçüsü

Minimum 80 cm







# TEZGAHÜSTÜ EVİYELER

COLIBRI	28
EUROSTAR	29
EUROMISS	29
ROTONDO	30-31
ONDALINE	32-33
SPARK	34
KÖŞE EVİYELER	35
LOGICALINE	36-37
ARMONIA	38-39
NEPTUN	40-41
GALASSIA	42
ACQUARIOLINE	43
LARGO	44-45
CRYSTAL GLASS	46-47

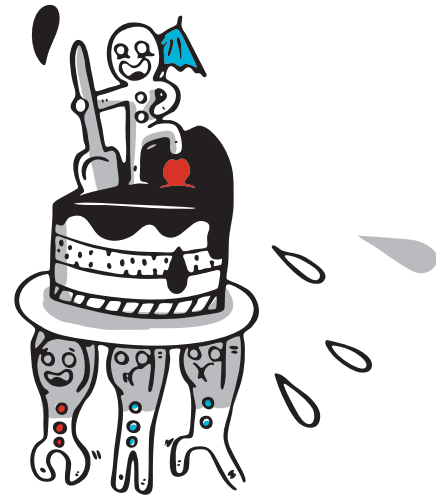

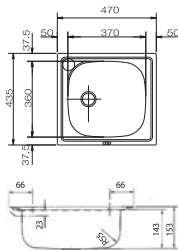

**CIN 610**  
**CIL 610**

**Inox**  
**Dekor**



**101.0168.612**  
**101.0168.619**



**Montaj tipi**  
**Ebat**  
**Montaj ölçüsü**  
**Birlikte verilen bağlantı**  
**Alt Dolap ölçüsü**

Tezgah Üstü  
470 x 435 mm  
450 x 415 mm  
112.0184.357  
Minimum 45 cm

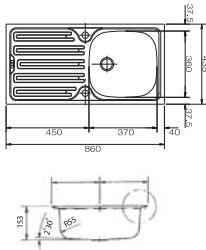

**CIN 611 SOL**  
**CIN 611 SAĞ**  
**CIL 611 SOL**  
**CIL 611 SAĞ**

**Inox**  
**Inox**  
**Dekor**  
**Dekor**



**101.0168.370**  
**101.0168.368**  
**101.0168.412**  
**101.0168.395**



**Montaj tipi**  
**Ebat**  
**Montaj ölçüsü**  
**Birlikte verilen bağlantı**  
**Alt Dolap ölçüsü**

Tezgah Üstü  
860 x 435 mm  
840 x 415 mm  
112.0184.357  
Minimum 45 cm

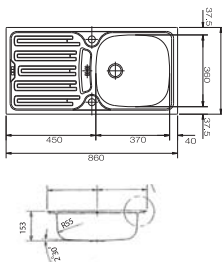

**CIN 614 SOL**  
**CIN 614 SAĞ**  
**CIL 614 SOL**  
**CIL 614 SAĞ**

**Inox**  
**Inox**  
**Dekor**  
**Dekor**



**101.0168.588**  
**101.0168.587**  
**101.0168.609**  
**101.0168.608**



**Montaj tipi**  
**Ebat**  
**Montaj ölçüsü**  
**Birlikte verilen bağlantı**  
**Alt Dolap ölçüsü**

Tezgah Üstü  
860 x 435 mm  
840 x 415 mm  
112.0184.349  
Minimum 45 cm



**Eurostar**

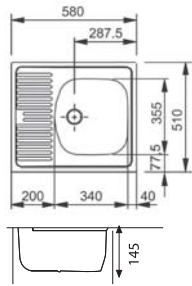

**ETN 611-58**

**Inox**

**101.0009.362**

Montaj tipi  
Ebat  
Montaj ölçüsü  
Birlikte verilen bağlantı  
Alt Dolap ölçüsü

Tezgah Üstü  
580 x 510 mm  
560x490 mm  
112.0006.230, sifon 112.0068.243  
Minimum 40 cm

Armatür deliği bulunmamaktadır.



**Eurostar**

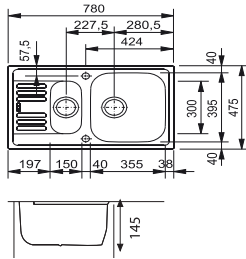

**EFN 651-78**

**Inox**

**101.0304.174**

Montaj tipi  
Ebat  
Montaj ölçüsü  
Birlikte verilen bağlantı  
Alt Dolap ölçüsü

Tezgah Üstü  
780 x 475 mm  
760x455 mm  
112.0006.263, sifon 112.0006.456  
Klips 112.0183.990  
Minimum 60 cm

Armatür deliği çift taraflı bulunmaktadır.



**Euromiss**

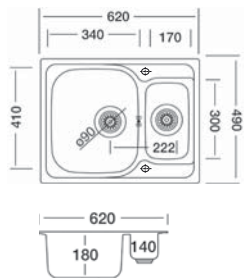

**EMX 660**

**EML 660**

**Inox**

**Dekor**

**101.0185.423**

**101.0185.424**

Montaj tipi  
Ebat  
Montaj ölçüsü  
Birlikte verilen bağlantı  
Alt Dolap ölçüsü

Tezgah Üstü  
620 x 490 mm  
600 x 470 mm  
112.0198.473  
Minimum 60 cm

Sifon kumandalıdır.



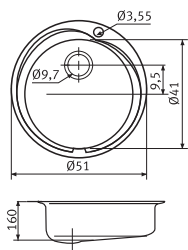

**ROX-6 10-4-1**

**Inox**

**101.0017.919**

**Montaj tipi**  
**Ebat**  
**Montaj ölçüsü**  
**Birlikte verilen bağlantı**  
**Alt Dolap ölçüsü**

Tezgah Üstü  
Ø510  
Ø 490  
112.0006.351, sifon 112.0068.243  
Minimum 60 cm

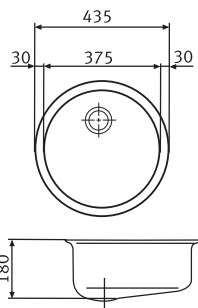

**RBX-6 10**

**Inox**

**101.0048.500**

**Montaj tipi**  
**Ebat**  
**Montaj ölçüsü**  
**Birlikte verilen bağlantı**  
**Alt Dolap ölçüsü**

Tezgah Üstü  
Ø 435  
Ø 410  
112.0158.351, sifon 112.0068.243  
Minimum 45 cm

Armatür deliği bulunmamaktadır.









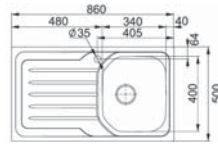

**OLX 611 SOL**  
**OLX 611 SAĞ**  
**OLL 611 SOL**  
**OLL 611 SAĞ**

**Inox**  **101.0456.090**  
**Inox**  **101.0456.087**  
**Dekor**  **101.0486.077**  
**Dekor**  **101.0486.076**

**Montaj tipi**  
**Ebat**  
**Montaj ölçüsü**  
**Birlikte verilen bağlantı**

Tezgah Üstü  
860 x 500 mm  
840 x 480 mm  
112.0059.982, klips 112.0183.990  
sifon 112.0184.359

**Alt Dolap ölçüsü**

Minimum 45 cm

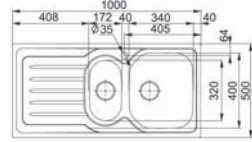

**OLX 651 SOL**  
**OLX 651 SAĞ**  
**OLL 651 SOL**  
**OLL 651 SAĞ**

**Inox**  **101.0456.486**  
**Inox**  **101.0456.484**  
**Dekor**  **101.0486.097**  
**Dekor**  **101.0486.093**

**Montaj tipi**  
**Ebat**  
**Montaj ölçüsü**  
**Birlikte verilen bağlantı**

Tezgah Üstü  
1000 x 500 mm  
980 x 480 mm  
112.0059.989, klips 112.0486.312  
sifon 112.0184.360

**Alt Dolap ölçüsü**

Minimum 60 cm

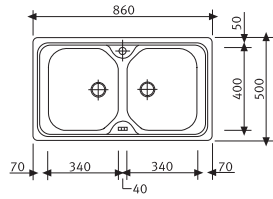

**OLX 620**  
**OLL 620**

**Inox**  **101.0486.100**  
**Dekor**  **101.0486.111**

**Montaj tipi**  
**Ebat**  
**Montaj ölçüsü**  
**Birlikte verilen bağlantı**

Tezgah Üstü  
860 x 500 mm  
840 x 480 mm  
112.0059.989, klips 112.0183.990  
sifon 112.0184.360

**Alt Dolap ölçüsü**

Minimum 80 cm

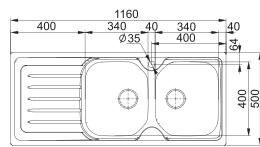

**OLX 621 SOL**  
**OLX 621 SAĞ**  
**OLL 621 SOL**  
**OLL 621 SAĞ**

**Inox**  **101.0486.113**  
**Inox**  **101.0486.112**  
**Dekor**  **101.0486.118**  
**Dekor**  **101.0486.117**

**Montaj tipi**  
**Ebat**  
**Montaj ölçüsü**  
**Birlikte verilen bağlantı**

Tezgah Üstü  
1160 x 500 mm  
1140 x 480 mm  
112.0059.989, klips 112.0486.312  
sifon 112.0068.244

**Alt Dolap ölçüsü**

Minimum 80 cm



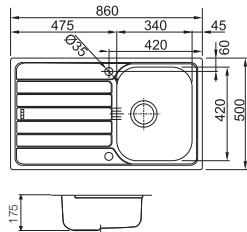

**SKX 611 SOL**

**SKX 611 SAĞ**

**SKL 611 SOL**

**SKL 611 SAĞ**

**Inox**

**Inox**

**Dekor**

**Dekor**

**101.0485.942**

**101.0485.910**

**101.0485.948**

**101.0485.947**

Montaj tipi

Ebat

Montaj ölçüsü

Birlikte verilen bağlantı

Tezgah Üstü

860 x 500 mm

840 x 480 mm

112.0059.982, sifon 112.0184.359

klips 112.0485.906

Minimum 45 cm

Alt Dolap ölçüsü

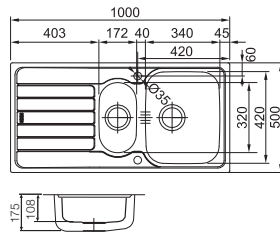

**SKX 651 SOL**

**SKX 651 SAĞ**

**SKL 651 SOL**

**SKL 651 SAĞ**

**Inox**

**Inox**

**Dekor**

**Dekor**

**101.0485.961**

**101.0485.950**

**101.0485.965**

**101.0485.964**

Montaj tipi

Ebat

Montaj ölçüsü

Birlikte verilen bağlantı

Tezgah Üstü

1000 x 500 mm

980 x 480 mm

112.0059.989, sifon 112.0184.360

klips 112.0485.907

Minimum 60 cm

Alt Dolap ölçüsü



**Spark köşe**

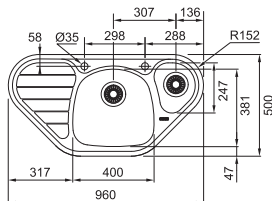

**SKX 651-E**

**Inox**

**101.0464.340**

Montaj tipi

Ebat

Montaj ölçüsü

Birlikte verilen bağlantı

Tezgah Üstü

Ebat 960 x 500 mm

Kutuların içinde şablon mevcut

112.0183.866, sifon 112.0184.360

klips 112.0012.785

45° Köşe

Alt Dolap ölçüsü



## Çelik Tel Sepet

112.0047.840  
340x400 mm



PNX 621-E / STX 621-E modelleri ile uyumludur.  
opsiyoneldir



### Progresso

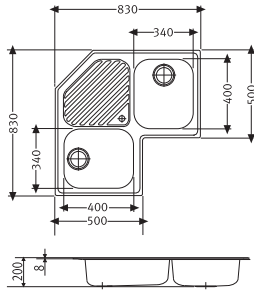

PNX 621-E

Inox



101.0021.585

Montaj tipi  
Ebat  
Montaj ölçüsü  
Birlikte verilen bağlantı  
Alt Dolap ölçüsü

Tezgah Üstü  
830 x 830 mm  
Kutuların içinde şablon mevcuttur.  
112.0059.982 (2 adet), sifon 112.0048.209  
90° Köşe



### Studio

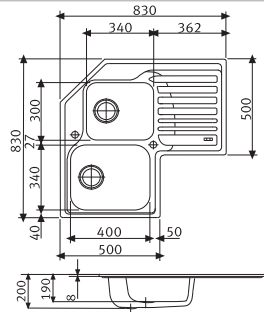

STX 621-E SOL  
STX 621-E SAĞ

Inox



101.0001.045

Inox



101.0001.044

Montaj tipi  
Ebat  
Montaj ölçüsü  
Birlikte verilen bağlantı  
Alt Dolap ölçüsü

Tezgah Üstü  
830 x 830 mm  
Kutuların içinde şablon mevcuttur.  
112.0059.989, sifon 112.0048.209  
90° Köşe



## Çelik Tel Sepet

112.0047.840  
340x400 mm



Logicaline serisi tüm modeller ile  
uyumludur  
**opsiyoneldir**



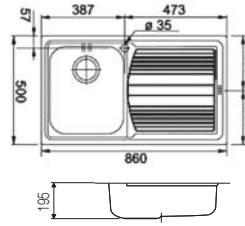

LLX 611 SOL  
LLX 611 SAĞ  
LLL 611 SOL  
LLL 611 SAĞ

**Inox**  101.0152.585  
**Inox**  101.0152.583  
**Dekor**  101.0152.591  
**Dekor**  101.0151.873

**Montaj tipi** Tezgah Üstü  
**Ebat** 860 x 500 mm  
**Montaj ölçüsü** 840 x 480 mm  
**Birlikte verilen bağlantı** 112.0059.982, sifon 112.0068.243 klips 1302222  
**Alt Dolap ölçüsü** Minimum 45 cm

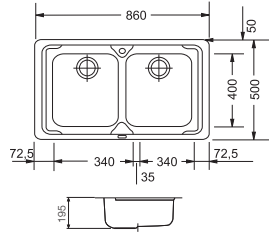

LLX 620

**Inox**  101.0021.626

**Montaj tipi** Tezgah Üstü  
**Ebat** 860 x 500 mm  
**Montaj ölçüsü** 840 x 480 mm  
**Birlikte verilen bağlantı** 112.0059.989, sifon 112.0068.244 klips 1302222  
**Alt Dolap ölçüsü** Minimum 80 cm

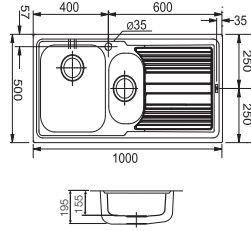

LLX 651 SOL  
LLX 651 SAĞ  
LLL 651 SOL  
LLL 651 SAĞ

**Inox**  101.0150.832  
**Inox**  101.0150.830  
**Dekor**  101.0152.587  
**Dekor**  101.0152.586

**Montaj tipi** Tezgah Üstü  
**Ebat** 1000 x 500 mm  
**Montaj ölçüsü** 980 x 480 mm  
**Birlikte verilen bağlantı** 112.0059.989, sifon 112.0048.209 klips 133.0048.423  
**Alt Dolap ölçüsü** Minimum 60 cm

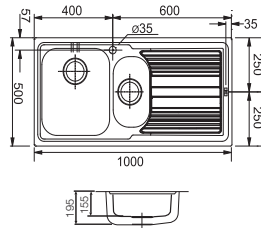

LLX 651-S  
LLL 651-S

**Inox**  101.0278.935  
**Dekor**  101.0278.937

**Montaj tipi** Tezgah Üstü  
**Ebat** 1000 x 500 mm  
**Montaj ölçüsü** 980 x 480 mm  
**Birlikte verilen bağlantı** 112.0059.989 - 112.0185.064 sifon 112.0048.209, klip 133.0048.423  
**Alt Dolap ölçüsü** Minimum 60 cm



Sifon kumandalıdır.



## Çelik Tel Sepet

112.0047.840  
340x400 mm

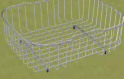

Armonia serisi tüm modeller ile uyumludur  
**opsiyoneldir**

## Çelik Yarım Hazne Süzgeci

112.0040.691  
165x306 mm



AMX 651 / AML 651 / AMT 651 modelleri ile uyumludur.  
**opsiyoneldir**



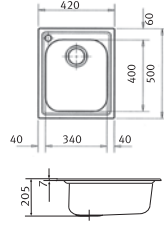

**AMX 610**

**Inox**



**101.0021.601**

**Montaj tipi**  
**Ebat**  
**Montaj ölçüsü**  
**Birlikte verilen bağlantı**  
**Alt Dolap ölçüsü**

Tezgah Üstü  
420 x 500 mm  
400 x 480 mm  
112.0059.982, sifon 112.0068.243  
Minimum 45 cm

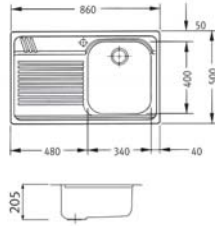

**AMX 611 SOL**  
**AMX 611 SAĞ**  
**AML 611 SOL**  
**AML 611 SAĞ**  
**AMT 611 SOL**  
**AMT 611 SAĞ**

**Inox**



**101.0022.493**

**Inox**

**101.0022.492**

**Dekor**



**101.0022.501**

**Dekor**

**101.0022.500**

**M.dekor**



**101.0022.583**

**M.dekor**

**101.0022.582**

**Montaj tipi**  
**Ebat**  
**Montaj ölçüsü**  
**Birlikte verilen bağlantı**

Tezgah Üstü  
860 x 500 mm  
840 x 480 mm  
112.0059.982, sifon 112.0068.243  
klips 1302214  
Minimum 45 cm

**Alt Dolap ölçüsü**

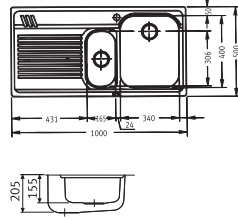

**AMX 651 SOL**  
**AMX 651 SAĞ**  
**AML 651 SOL**  
**AML 651 SAĞ**  
**AMT 651 SOL**  
**AMT 651 SAĞ**

**Inox**



**101.0022.497**

**Inox**

**101.0022.496**

**Dekor**



**101.0022.503**

**Dekor**

**101.0022.502**

**M.dekor**



**101.0022.587**

**M.dekor**

**101.0022.586**

**Montaj tipi**  
**Ebat**  
**Montaj ölçüsü**  
**Birlikte verilen bağlantı**

Tezgah Üstü  
1000 x 500 mm  
980 x 480 mm  
112.0059.989, sifon 112.0048.209  
klips 133.0048.423  
Minimum 60 cm

**Alt Dolap ölçüsü**

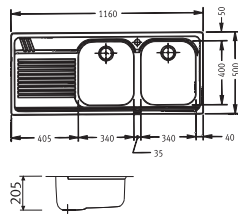

**AMX 621 SOL**  
**AMX 621 SAĞ**  
**AML 621 SOL**  
**AML 621 SAĞ**  
**AMT 621 SOL**  
**AMT 621 SAĞ**

**Inox**



**101.0022.499**

**Inox**

**101.0022.498**

**Dekor**



**101.0022.505**

**Dekor**

**101.0022.504**

**M.dekor**



**101.0022.585**

**M.dekor**

**101.0022.584**

**Montaj tipi**  
**Ebat**  
**Montaj ölçüsü**  
**Birlikte verilen bağlantı**

Tezgah Üstü  
1160 x 500 mm  
1140 x 480 mm  
112.0059.989, sifon 112.0068.244  
klips 133.0048.423  
Minimum 80 cm

**Alt Dolap ölçüsü**





Polietilen +Çelik  
Süzgeç

112.0049.603  
320x450 mm

Neptun Serisi tüm modeller ile  
uyumludur.  
opsiyonel



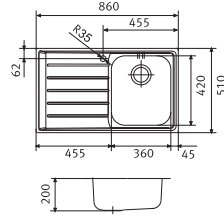

**NEX 611 SOL**  
**NEX 611 SAĞ**  
**NET 611 SOL**  
**NET 611 SAĞ**



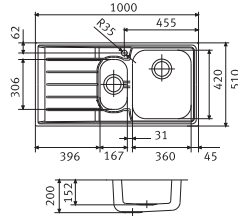
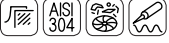

**Inox**  **101.0040.715**  
**Inox**  **101.0040.713**  
**M.dekor**  **101.0040.722**  
**M.dekor**  **101.0040.721**

**Montaj tipi** Tezgah Üstü  
**Ebat** 860 x 510 mm  
**Montaj ölçüsü** 840 x 490 mm  
**Birlikte verilen bağlantı** 112.0049.427-112.0049.409

sifon 112.0068.243, klips 133.0175.715  
**Alt Dolap ölçüsü** Minimum 60 cm



**NEX 651 SOL**  
**NEX 651 SAĞ**  
**NET 651 SOL**  
**NET 651 SAĞ**



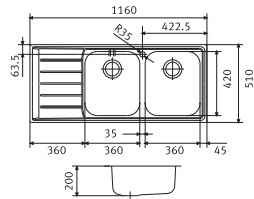
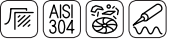

**Inox**  **101.0040.720**  
**Inox**  **101.0040.719**  
**M.dekor**  **101.0040.728**  
**M.dekor**  **101.0040.727**

**Montaj tipi** Tezgah Üstü  
**Ebat** 1000 x 510 mm  
**Montaj ölçüsü** 980 x 490 mm  
**Birlikte verilen bağlantı** 133.0254.555 - 112.0049.409

112.0049.406, sifon 112.0048.209  
klips 133.0175.715  
**Alt Dolap ölçüsü** Minimum 60 cm



**NEX 621 SOL**  
**NEX 621 SAĞ**  
**NET 621 SOL**  
**NET 621 SAĞ**

**Inox**  **101.0040.718**  
**Inox**  **101.0040.717**  
**M.dekor**  **101.0040.726**  
**M.dekor**  **101.0040.725**

**Montaj tipi** Tezgah Üstü  
**Ebat** 1160 x 510 mm  
**Montaj ölçüsü** 1140 x 490 mm  
**Birlikte verilen bağlantı** 112.0049.427 112.0049.409

112.0049.406, sifon 112.0068.244  
klips 133.0175.719  
**Alt Dolap ölçüsü** Minimum 80 cm

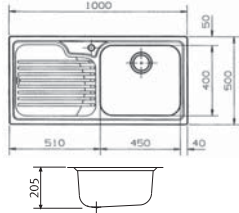
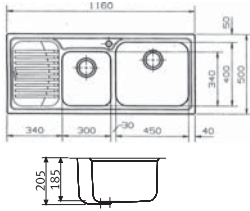

## Çelik Tel Sepet

112.0047.841  
260x300 mmGalassia Serisi tüm modeller ile uyumludur.  
opsiyonelGAX 611 SOL  
GAX 611 SAĞInox  
Inox101.0022.565  
101.0022.564Montaj tipi  
Ebat  
Montaj ölçüsü  
Birlikte verilen bağlantı  
Alt Dolap ölçüsüTezgah Üstü  
1000 x 500 mm  
980 x 480 mm  
112.0059.982, sifon 112.0068.243  
klips 133.0048.423  
Minimum 60 cmGAX 621 SOL  
GAX 621 SAĞInox  
Inox101.0022.567  
101.0022.566Montaj tipi  
Ebat  
Montaj ölçüsü  
Birlikte verilen bağlantı  
Alt Dolap ölçüsüTezgah Üstü  
1160 x 500 mm  
1140 x 480 mm  
112.0059.989, sifon 112.0048.209  
klips 133.0048.423  
Minimum 90 cm

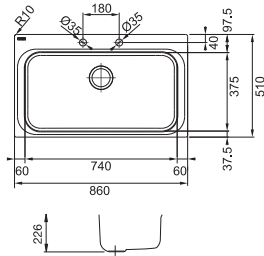

AEX 610-A

Inox

101.0199.089

Montaj tipi  
Ebat  
Montaj ölçüsü  
Birlikte verilen bağlantı

Tezgah Üstü  
860 x 510 mm  
840 x 490 mm  
112.0073.192, sifon 112.0068.243  
klips 133.0048.423  
Minimum 90 cm

Alt Dolap ölçüsü

Sifon kumandalıdır.  
Aksesuarları dahildir.



## ACQUARIO'YA DAHİL AKSESUARLAR

### Çelik Hazne

112.0199.085  
300x340 mm



### Çelik Tepsi

112.0199.086



### Kesme Tahtası

112.0199.087



### Çelik Tel Sepet

112.0199.083





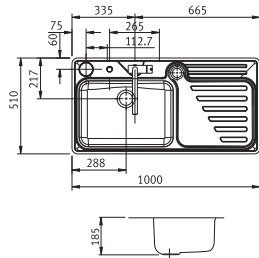

LAX 614 SOL  
LAX 614 SAĞ

Inox  
Inox

101.0043.752  
101.0043.750

Montaj tipi  
Ebat  
Montaj ölçüsü  
Radius  
Birlikte verilen bağlantı

Tezgah Üstü  
1000 x 510 mm  
984x494 mm  
+0/-3 mm R20  
112.0173.076 - 133.0036.529  
133.0007.799, sifon 112.0048.206  
klips 992.0031.908  
Minimum 80 cm

Alt Dolap ölçüsü

Pop-up sifon kumandalıdır.  
Aksesuarları dahildir.



## LARGO'YA DAHİL AKSESUARLAR



### Largo Bıçak Seti

112.0016.395  
Üçlü Bıçak Seti  
112.0016.394  
Ahşap Bıçaklık



### Yarım Hazne Süzgeci

112.0061.838



### Eviyeye Entegre Çelik Bıçaklık

112.0016.337



### Hareketli Kesme Tahtası

112.0039.125



### Sıvı Sabunluk Detarjanlık

119.0041.494



## Çelik Esnek Süzgeç

112.0030.882

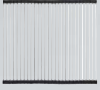

Crystal Glass Serisi tüm modeller ile uyumludur.  
opsiyoneldir

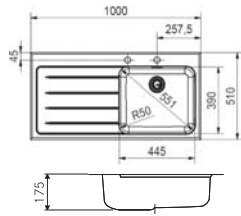

EOV 611 SOL	White	101.0150.348
EOV 611 SAĞ	White	101.0150.349
EOV 611 SOL	Black	101.0150.351
EOV 611 SAĞ	Black	101.0150.350

Montaj tipi	Tezgah Üstü
Ebat	1000 x 510 x 175 mm
Montaj ölçüsü	980x490 mm
Radius	0-10 mm köşe yarı çapı
Birlikte verilen bağlantı	133.0171.342 - 133.0036.506 133.0085.915 - 112.0173.076
Alt Dolap ölçüsü	Minimum 60 cm

Sifon kumandalıdır.

Damlalıkta çizilmelere dayanıklı mat cam yüzey



## Çelik Esnek Süzgeç

112.0030.882



Crystal Glass Serisi tüm modeller ile uyumludur.  
**opsiyoneldir**

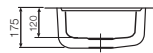
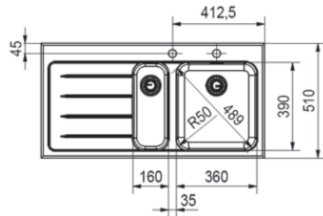

EOV 651 SOL	White	101.0157.954
EOV 651 SAĞ	White	101.0157.955
EOV 651 SOL	Black	101.0157.953
EOV 651 SAĞ	Black	101.0157.952



Montaj tipi	Tezgah Üstü
Ebat	1000 x 510 x 175 mm
Montaj ölçüsü	980x490 mm
Radius	0-10 mm köşe yarı çapı
Birlikte verilen bağlantı	133.0171.342 - 133.0036.506 133.0085.915 - 133.0052.765 112.0049.409 - 112.0173.076
Alt Dolap ölçüsü	Minimum 60 cm

Sifon kumandalıdır.

Damlalıkta çizilmelere dayanıklı mat cam yüzey



Eviye özelliklerine ait sembollerinin açıklamalarını öğrenmek için arka kapak içindeki tabloyu inceleyebilirsiniz.







Tezgahaltı, Tezgahüstü veya Tezgaha '0' olarak 3 farklı kullanım imkanı



Tüm Box serisi eviyeler üzerinde armatür deliği bulunmamaktadır. Armatür tezgaha monte edilebilir.

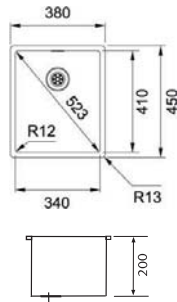

**BXX 210/110-34**

**Inox**

**127.0369.056**

**Montaj tipi**  
**Ebat**  
**Montaj ölçüsü**  
**Birlikte verilen bağlantı**

Tezgah Altı, Tezgah Üstü yada Tezgaha Sıfır  
380 x 450 mm  
Kutuların içinde şablon mevcuttur  
112.0049.409 - 133.0254.554  
sifon 112.0048.206, klips 133.0172.567  
Minimum 45 cm

**Alt Dolap ölçüsü**

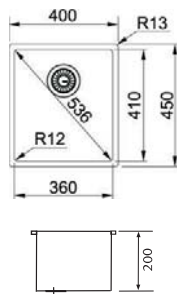

**BXX 210/110-36**

**Inox**

**127.0369.913**

**Montaj tipi**  
**Ebat**  
**Montaj ölçüsü**  
**Birlikte verilen bağlantı**

Tezgah Altı, Tezgah Üstü yada Tezgaha Sıfır  
400 x 450 mm  
Kutuların içinde şablon mevcuttur  
112.0049.409 - 133.0254.554  
sifon 112.0048.206, klips 133.0172.567  
Minimum 45 cm

**Alt Dolap ölçüsü**

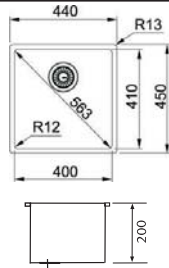

**BXX 210/110-40****Inox****127.0369.215**

Montaj tipi  
Ebat  
Montaj ölçüsü  
Birlikte verilen bağlantı  
Alt Dolap ölçüsü

Tezgah Altı, Tezgah Üstü yada Tezgaha Sıfır  
440 x 450 mm  
Kutuların içinde şablon mevcuttur  
112.0049.409 - 133.0254.554  
sifon 112.0048.206, klips 133.0172.567  
Minimum 50 cm

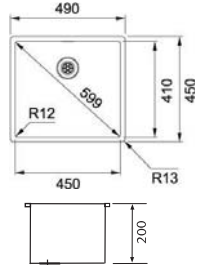
**BXX 210/110-45****Inox****127.0369.250**

Montaj tipi  
Ebat  
Montaj ölçüsü  
Birlikte verilen bağlantı  
Alt Dolap ölçüsü

Tezgah Altı, Tezgah Üstü yada Tezgaha Sıfır  
490 x 450 mm  
Kutuların içinde şablon mevcuttur  
112.0049.409 - 133.0254.554  
sifon 112.0048.206, klips 133.0172.567  
Minimum 55 cm

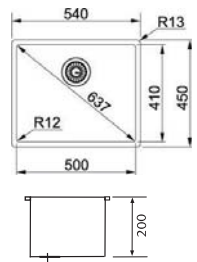
**BXX 210/110-50****Inox****127.0369.282**

Montaj tipi  
Ebat  
Montaj ölçüsü  
Birlikte verilen bağlantı  
Alt Dolap ölçüsü

Tezgah Altı, Tezgah Üstü yada Tezgaha Sıfır  
540 x 450 mm  
Kutuların içinde şablon mevcuttur  
112.0049.409 - 133.0254.554  
sifon 112.0048.206, klips 133.0172.567  
Minimum 60 cm

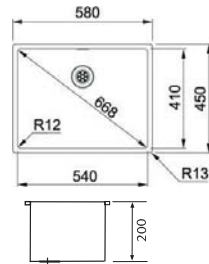
**BXX 210/110-54****Inox****127.0371.513**

Montaj tipi  
Ebat  
Montaj ölçüsü  
Birlikte verilen bağlantı  
Alt Dolap ölçüsü

Tezgah Altı, Tezgah Üstü yada Tezgaha Sıfır  
580 x 450 mm  
Kutuların içinde şablon mevcuttur  
112.0049.409 - 133.0254.554  
sifon 112.0048.206, klips 133.0172.567  
Minimum 80 cm

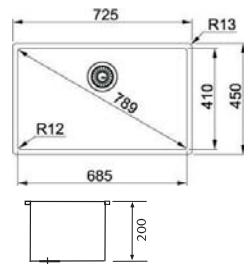
**BXX 210/110-68****Inox****127.0369.284**

Montaj tipi  
Ebat  
Montaj ölçüsü  
Birlikte verilen bağlantı  
Alt Dolap ölçüsü

Tezgah Altı, Tezgah Üstü yada Tezgaha Sıfır  
725 x 450 mm  
Kutuların içinde şablon mevcuttur  
112.0049.409 - 133.0254.554  
sifon 112.0048.206, klips 133.0172.567  
Minimum 80 cm

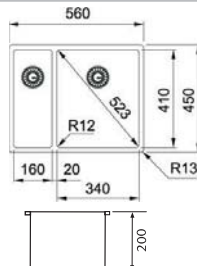
**BXX 260/160 34-16****Inox****127.0369.916**

Montaj tipi  
Ebat  
Montaj ölçüsü  
Birlikte verilen bağlantı  
Alt Dolap ölçüsü

Tezgah Altı, Tezgah Üstü yada Tezgaha Sıfır  
560 x 450 mm  
Kutuların içinde şablon mevcuttur  
133.0254.554 - 133.0254.556  
112.0049.409  
sifon 112.0048.209, klips 133.0172.567  
Minimum 60 cm

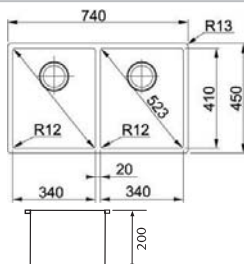
**BXX 220/120 34-34****Inox****127.0370.188**

Montaj tipi  
Ebat  
Montaj ölçüsü  
Birlikte verilen bağlantı  
Alt Dolap ölçüsü

Tezgah Altı, Tezgah Üstü yada Tezgaha Sıfır  
740 x 450 mm  
Kutuların içinde şablon mevcuttur  
112.0049.409 - 133.0254.554  
sifon 112.0048.209, klips 133.0172.567  
Minimum 80 cm





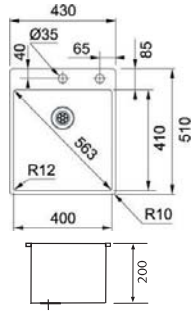

**BXX 210-40**

**Inox**

**127.0369.288**

Montaj tipi  
Ebat  
Montaj ölçüsü  
Birlikte verilen bağlantı

Tezgah Üstü yada Tezgaha Sıfır  
430x510 mm  
Kutuların içinde şablon mevcuttur.  
112.0173.076 - 133.0254.554  
133.0171.342 - 992.0367.561  
sifon 112.0048.206

Alt Dolap ölçüsü

Minimum 45 cm

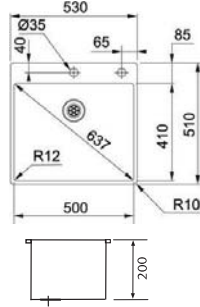

**BXX 210-50**

**Inox**

**127.0369.289**

Montaj tipi  
Ebat  
Montaj ölçüsü  
Birlikte verilen bağlantı

Tezgah Üstü yada Tezgaha Sıfır  
530x510 mm  
Kutuların içinde şablon mevcuttur.  
112.0173.076 - 133.0254.554  
133.0171.342 - 992.0367.561  
sifon 112.0048.206

Alt Dolap ölçüsü

Minimum 55 cm

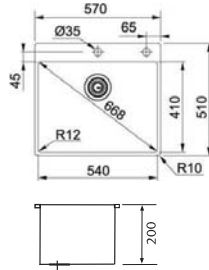

**BXX 210-54**

**Inox**

**127.0369.295**

Montaj tipi  
Ebat  
Montaj ölçüsü  
Birlikte verilen bağlantı

Tezgah Üstü yada Tezgaha Sıfır  
570x510 mm  
Kutuların içinde şablon mevcuttur.  
112.0173.076 - 133.0254.554  
133.0171.342 - 992.0367.561  
sifon 112.0048.206

Alt Dolap ölçüsü

Minimum 60 cm

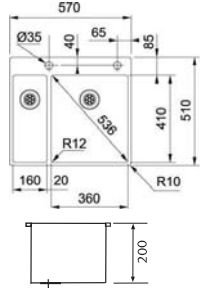

**BXX 260 36-16**

**Inox**

**127.0379.889**

Montaj tipi  
Ebat  
Montaj ölçüsü  
Birlikte verilen bağlantı

Tezgah Üstü yada Tezgaha Sıfır  
570x510 mm  
Kutuların içinde şablon mevcuttur.  
133.0254.554 - 133.0254.556  
112.0173.076 - 112.0049.409  
133.0171.342, sifon 112.0048.209  
klips 992.0367.561

Alt Dolap ölçüsü

Minimum 60 cm

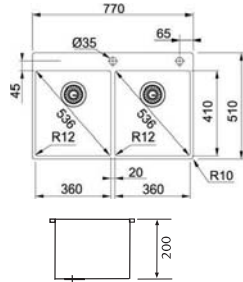

**BXX 220 36-36**

**Inox**

**127.0369.314**

Montaj tipi  
Ebat  
Montaj ölçüsü  
Birlikte verilen bağlantı

Tezgah Üstü yada Tezgaha Sıfır  
770x510 mm  
Kutuların içinde şablon mevcuttur.  
112.0173.076 - 133.0254.554  
133.0171.342 - 992.0367.561  
112.0049.409, sifon 112.0048.206

Alt Dolap ölçüsü

Minimum 80 cm

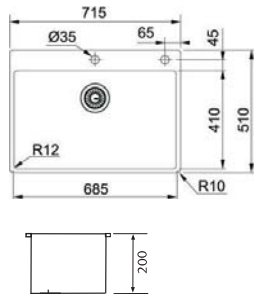

**BXX 210-68**

**Inox**

**127.0378.049**

Montaj tipi  
Ebat  
Montaj ölçüsü  
Birlikte verilen bağlantı

Tezgah Üstü yada Tezgaha Sıfır  
715x510 mm  
Kutuların içinde şablon mevcuttur.  
112.0173.076 - 133.0254.554  
133.0171.342 - 992.0367.561  
sifon 112.0048.206

Alt Dolap ölçüsü

Minimum 80 cm



## Polietilen +Çelik Süzgeç

112.0049.603  
320x450 mm

Neptun Slimtop Serisi tüm modeller  
ile uyumludur.  
**opsiyonel**

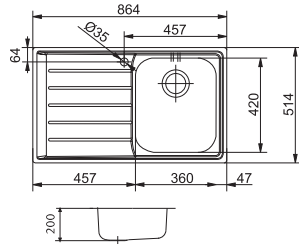

**NEX 211 SOL**  
**NEX 211 SAĞ**

**Inox**



**127.0059.655**

**Inox**

**127.0059.654**

**Montaj tipi**  
**Ebat**  
**Montaj ölçüsü**  
**Birlikte verilen bağlantı**

Tezgah Üstü yada Tezgaha Sıfır  
864x514 mm  
Kutuların içinde şablon mevcuttur.  
133.0036.427 - 112.0049.409  
sifon 112.0068.243, klips 133.0175.719  
Minimum 60 cm

**Alt Dolap ölçüsü**

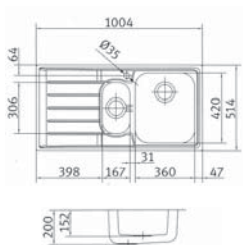

**NEX 251 SOL**  
**NEX 251 SAĞ**

**Inox**



**127.0059.717**

**Inox**

**127.0059.658**

**Montaj tipi**  
**Ebat**  
**Montaj ölçüsü**  
**Birlikte verilen bağlantı**

Tezgah Üstü yada Tezgaha Sıfır  
1004x514 mm  
Kutuların içinde şablon mevcuttur.  
112.0049.406 - 112.0049.409  
sifon 112.0048.209, klips 133.0175.719  
Minimum 60 cm

**Alt Dolap ölçüsü**



## Çelik Yarım Hazne Süzgeci

112.0199.112

Aton Slimtop Serisi tüm modeller ile uyumludur.  
opsiyoneldir.

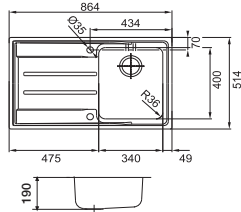

**ANX 211 SOL**  
**ANX 211 SAĞ**

**Inox**  
**Inox**

**127.0204.401**  
**127.0204.400**

**Montaj tipi**  
**Ebat**  
**Montaj ölçüsü**  
**Birlikte verilen bağlantı**

Tezgah Üstü yada Tezgaha Sıfır  
864x514 mm  
Kutuların içinde şablon mevcuttur.  
112.0173.076 - 133.0173.094  
133.0171.326 sifon 112.0048.206  
klips 133.0175.719  
Minimum 60 cm

**Alt Dolap ölçüsü**

Sifon kumandalıdır.

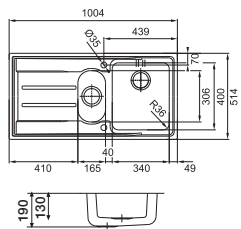

**ANX 251 SOL**  
**ANX 251 SAĞ**

**Inox**  
**Inox**

**127.0204.610**  
**127.0204.603**

**Montaj tipi**  
**Ebat**  
**Montaj ölçüsü**  
**Birlikte verilen bağlantı**

Tezgah Üstü yada Tezgaha Sıfır  
1004x514 mm  
Kutuların içinde şablon mevcuttur.  
112.0173.072 - 112.0049.409  
133.0254.559 - 133.0172.326  
sifon 112.0048.209, klips 133.0175.719  
Minimum 60 cm

**Alt Dolap ölçüsü**

Sifon kumandalıdır.

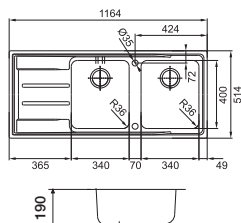

**ANX 221 SOL**  
**ANX 221 SAĞ**

**Inox**  
**Inox**

**127.0204.631**  
**127.0204.625**

**Montaj tipi**  
**Ebat**  
**Montaj ölçüsü**  
**Birlikte verilen bağlantı**

Tezgah Üstü yada Tezgaha Sıfır  
1164x514 mm  
Kutuların içinde şablon mevcuttur.  
112.0049.406 - 112.0173.076  
133.0173.094 - 133.0171.326  
sifon 112.0048.209, klips 133.0203.578  
Minimum 80 cm

**Alt Dolap ölçüsü**

Sifon kumandalıdır.



Eviye özelliklerine ait sembollerinin açıklamalarını öğrenmek için arka kapak içindeki tabloyu inceleyebilirsiniz.





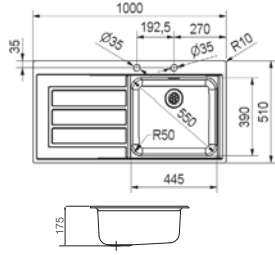

**EOX 211 SOL**  
**EOX 211 SAĞ**

**Inox**  **127.0279.690**  
**Inox**  **127.0279.701**

**Montaj tipi**  
**Ebat**  
**Montaj ölçüsü**  
**Birlikte verilen bağlantı**

Tezgah Üstü yada Tezgaha Sıfır  
1000 x 510 mm  
989x499 mm, r 0-10 mm  
112.0173.079 - 133.0036.506  
133.0171.327 - 133.0020.503  
133.0026.896, sifon 112.0059.946  
klips 992.0159.584  
Minimum 60 cm

**Alt Dolap ölçüsü**

Sifon kumandalıdır.  
Aksesuarlar dahildir



Gider dizaynı çöp öğütücüsü kullanımına uygun değildir.

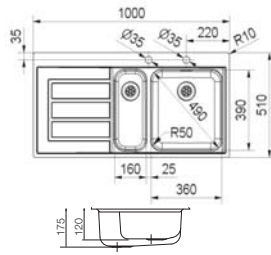

**EOX 251 SOL**  
**EOX 251 SAĞ**

**Inox**  **127.0279.688**  
**Inox**  **127.0279.689**

**Montaj tipi**  
**Ebat**  
**Montaj ölçüsü**  
**Birlikte verilen bağlantı**

Tezgah Üstü yada Tezgaha Sıfır  
1000 x 510 mm  
989x499 mm, r 0-10 mm  
112.0173.079 - 112.0049.411  
133.0036.506 - 133.0171.327  
133.0020.503 - 133.0026.896  
sifon 112.0052.536 klips 992.0159.584  
Minimum 60 cm

**Alt Dolap ölçüsü**

Sifon kumandalıdır.  
Aksesuarlar dahildir



Gider dizaynı çöp öğütücüsü kullanımına uygun değildir.

## EPOS'A DAHİL AKSESUARLAR

**Ahşap Doğrama  
Tahtası**  
112.0079.600



**Çelik Süzgeç**

112.0081.491

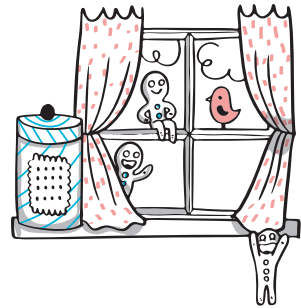

Çelik Yarım Hazne  
Süzgeci

112.0042.960  
230x426 mm



PPX 210-44 / PPX 210-58 / PPX 211  
PPX 251 modelleri ile uyumludur.  
opsiyoneldir

Çelik Esnek  
Süzgeç

112.0030.882



PPX 211 / PPX 251 modelleri ile  
uyumludur.  
opsiyoneldir



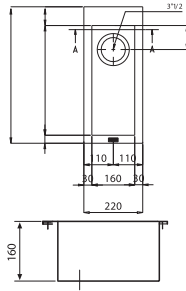

**PPX 210-22**

**Inox**



**127.0198.332**

**Montaj tipi**  
**Ebat**  
**Montaj ölçüsü**  
**Birlikte verilen bağlantı**

Tezgah Üstü yada Tezgaha Sıfır  
220x470 mm  
Kutuların içinde şablon mevcuttur.  
112.0049.409, 133.0254.556 sifon  
112.0048.206, klips 133.0203.578

**Alt Dolap ölçüsü**

Minimum 30 cm

Armatür deliği bulunmamaktadır.

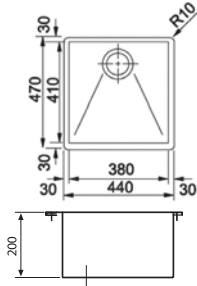

**PPX 210-44**

**Inox**



**127.0198.311**

**Montaj tipi**  
**Ebat**  
**Montaj ölçüsü**  
**Birlikte verilen bağlantı**

Tezgah Üstü yada Tezgaha Sıfır  
440x470 mm  
Kutuların içinde şablon mevcuttur.  
112.0049.409, 133.0203.578  
133.0254.554, sifon 112.0048.206

**Alt Dolap ölçüsü**

Minimum 45 cm

Armatür deliği bulunmamaktadır.

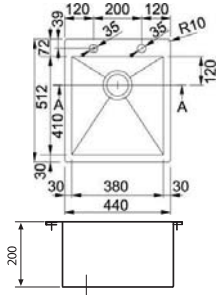

**PPX 210-44**

**Inox**



**127.0203.470**

**Montaj tipi**  
**Ebat**  
**Montaj ölçüsü**  
**Birlikte verilen bağlantı**

Tezgah Üstü yada Tezgaha Sıfır  
440x512 mm  
Kutuların içinde şablon mevcuttur.  
112.0173.076 133.0171.342  
133.0254.554, klips 133.0203.578  
sifon 112.0048.206

**Alt Dolap ölçüsü**

Minimum 45 cm

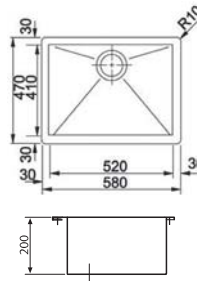

**PPX 210-58**

**Inox**



**127.0198.245**

**Montaj tipi**  
**Ebat**  
**Montaj ölçüsü**  
**Birlikte verilen bağlantı**  
**Alt Dolap ölçüsü**

Tezgah Üstü yada Tezgaha Sıfır  
580x470 mm  
Kutuların içinde şablon mevcuttur.  
112.0049.409, sifon 112.0048.206  
Minimum 60 cm

Armatür deliği bulunmamaktadır.

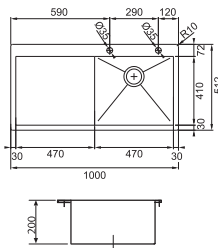

**PPX 211 SOL**

**Inox**



**127.0203.465**

**PPX 211 SAĞ**

**Inox**



**127.0203.464**

**Montaj tipi**  
**Ebat**  
**Montaj ölçüsü**  
**Birlikte verilen bağlantı**

Tezgah Üstü yada Tezgaha Sıfır  
1000x512 mm  
Kutuların içinde şablon mevcuttur.  
112.0173.076 - 133.0254.554  
klips 133.0171.342, sifon 112.0048.206

**Alt Dolap ölçüsü**

Minimum 60 cm

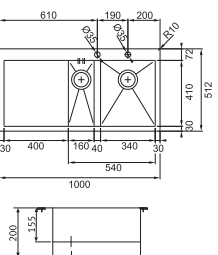

**PPX 251 SOL**

**Inox**



**127.0203.468**

**PPX 251 SAĞ**

**Inox**



**127.0203.467**

**Montaj tipi**  
**Ebat**  
**Montaj ölçüsü**  
**Birlikte verilen bağlantı**

Tezgah Üstü yada Tezgaha Sıfır  
1000x512 mm  
Kutuların içinde şablon mevcuttur.  
112.0173.072 - 133.0254.556,  
112.0049.409, 133.0171.342  
sifon 112.0048.209, klips 133.0203.578

**Alt Dolap ölçüsü**

Minimum 60 cm



## Çelik Esnek Süzgeç

112.0030.882



Mythos Slimtop Serisi tüm modeller  
ile uyumludur.  
opsiyoneldir

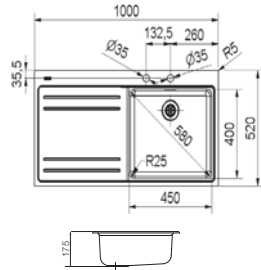

**MTX 211 SOL**  
**MTX 211 SAĞ**

**Inox**

**127.0279.638**

**Inox**

**127.0279.640**

**Montaj tipi**  
**Ebat**  
**Montaj ölçüsü**  
**Birlikte verilen bağlantı**

Tezgah Üstü yada Tezgaha Sıfır  
1000x520 mm  
991x511,R 0-10 mm  
112.0173.079 - 133.0036.506  
133.0171.342 - 133.0280.550  
sifon 112.0059.946  
Minimum 60 cm

**Alt Dolap ölçüsü**

Sifon kumandalıdır.  
Aksesuarlar dahildir

Gider dizaynı çöp öğütücüsü kullanımına uygun değildir.

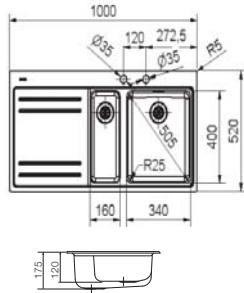

**MTX 251 SOL**  
**MTX 251 SAĞ**

**Inox**

**127.0279.684**

**Inox**

**127.0279.685**

**Montaj tipi**  
**Ebat**  
**Montaj ölçüsü**  
**Birlikte verilen bağlantı**

Tezgah Üstü yada Tezgaha Sıfır  
1000x520 mm  
991x511,R 0-10 mm  
112.0173.079 - 133.0036.506  
133.0171.342 - 133.0280.550  
112.0049.411, sifon 112.0052.536  
Minimum 60 cm

**Alt Dolap ölçüsü**

Sifon kumandalıdır.  
Aksesuarlar dahildir

Gider dizaynı çöp öğütücüsü kullanımına uygun değildir.



## MYTHOS'A DAHİL AKSESUARLAR

**Kesme Tahtası**

112.0046.415



**Yarım Hazne  
Süzgeci**

112.0057.850



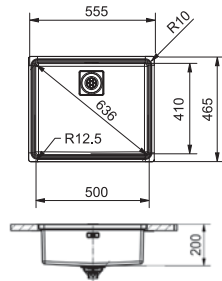

CEX 210/6 10-50

Inox

127.0184.591

Montaj tipi  
Ebat  
Montaj ölçüsü  
Birlikte verilen bağlantı

Tezgah Üstü yada Tezgaha Sıfır  
555x465 mm R10  
537x447 mm R0-30 mm  
112.0173.079 - 133.0036.506  
133.0175.465 - 112.0083.147  
sifon 112.0059.946, klips 112.0254.764  
Minimum 60 cm

Alt Dolap ölçüsü

Sifon kumandalıdır.  
Aksesuarlar dahildir  
Franke Global 100. yıl özel ürünüdür.



Gider dizaynı çöp öğütücüsü kullanımına uygun değildir.

## CENTINOX'A DAHİL AKSESUARLAR



reddot design award

Dünyanın en eski ve en prestijli ödülü olarak kabul edilen reddot design award Centinox eviyeyi bu ödüle layık görmüştür.

Çelik Damlalık

112.0173.587

Inox+Polietilen  
Keme Tahtası

112.0173.062

Esnek Çelik  
Süzgeç

112.0173.411



Çelik Süzgeç

112.0172.452



Krom Sabunluk

119.0176.057



opsiyoneldir



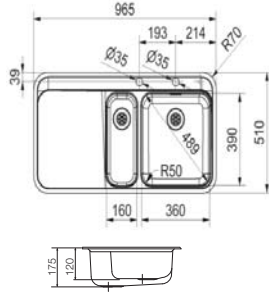

**SNX 251 SOL**  
**SNX 251 SAĞ**

**Inox**   
**Inox** 

**127.0279.686**  
**127.0279.687**

**Montaj tipi**  
**Ebat**  
**Montaj ölçüsü**  
**Birlikte verilen bağlantı**

Tezgah Üstü yada Tezgaha Sıfır  
965x510 mm  
952x497 mm R 64 mm  
112.0257.969 - 112.0257.965  
133.0036.506 - 133.0256.086  
133.0026.896 - 133.0280.550  
klips 992.0159.584, sifon 112.0052.536  
Minimum 60 cm

**Alt Dolap ölçüsü**

Sifon kumandalıdır.  
Aksesuarlar dahildir



Gider dizaynı çöp öğütücüsü kullanımına uygun değildir.

## SINOS'A DAHİL AKSESUARLAR

**Kesme Tahtası**

112.0255.966



**Yarım Hazne  
Süzgeci**

112.0081.491



**Esnek Çelik  
Süzgeç**

112.0256.867





**Çelik Yarım Hazne  
Süzgeci**

112.0042.960  
230x426 mm



Crystal Line Slimtop Serisi tüm modeller ile uyumludur.  
**opsiyoneldir**

**Çelik Esnek  
Süzgeç**

112.0030.882



CLV 2 14 modeli ile uyumludur.  
**opsiyoneldir**



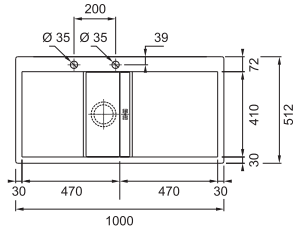

**CLV 214 SAĞ**  
**CLV 214 SOL**

**Inox+Black**  
**Inox+Black**

**127.0306.386**  
**127.0306.387**

**Montaj tipi**  
**Ebat**  
**Montaj ölçüsü**  
**Birlikte verilen bağlantı**

Tezgah Üstü yada Tezgaha Sıfır  
1000x512 mm  
Kutuların içinde şablon mevcuttur  
112.0173.076 - 112.0362.781  
133.0171.342, sifon 112.0048.206  
klips 133.0203.578  
Minimum 60 cm

**Alt Dolap ölçüsü**

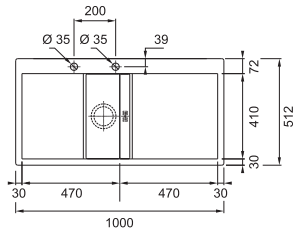
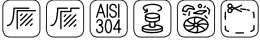

**CLV 214 SAĞ**  
**CLV 214 SOL**

**Inox+White**  
**Inox+White**

**127.0306.411**  
**127.0306.413**

**Montaj tipi**  
**Ebat**  
**Montaj ölçüsü**  
**Birlikte verilen bağlantı**

Tezgah Üstü yada Tezgaha Sıfır  
1000x512 mm  
Kutuların içinde şablon mevcuttur  
112.0173.076 - 112.0362.781  
133.0171.342, sifon 112.0048.206  
klips 133.0203.578  
Minimum 60 cm

**Alt Dolap ölçüsü**

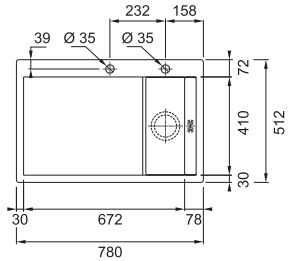
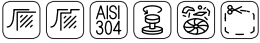

**CLV 210**

**Inox+Black**

**127.0306.327**

**Montaj tipi**  
**Ebat**  
**Montaj ölçüsü**  
**Birlikte verilen bağlantı**

Tezgah Üstü yada Tezgaha Sıfır  
780x512 mm  
Kutuların içinde şablon mevcuttur  
112.0173.076 - 112.0362.781  
133.0171.342, sifon 112.0048.206  
klips 133.0203.578  
Minimum 80 cm

**Alt Dolap ölçüsü**

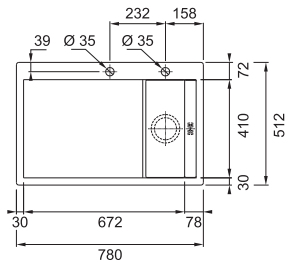

**CLV 210**

**Inox+White**

**127.0306.381**

**Montaj tipi**  
**Ebat**  
**Montaj ölçüsü**  
**Birlikte verilen bağlantı**

Tezgah Üstü yada Tezgaha Sıfır  
780x512 mm  
Kutuların içinde şablon mevcuttur  
112.0173.076 - 112.0362.781  
133.0171.342, sifon 112.0048.206  
klips 133.0203.578  
Minimum 80 cm

**Alt Dolap ölçüsü**

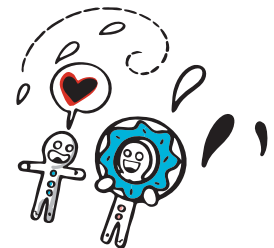



# TECTONITE & GRANİT EVIYELER

SIRIUS TECTONITE	70-71
KUBUS TEZGAHALTI	72-73
ANTEA	74-75
KÖŞE EVİYELER	75
BASIS	76-77
MARIS	78-79
PEBEL	80
JAVA	81
ACQUARIO	82
STYLE	83
MYTHOS FUSION	84-85





# DOĞAL RENK & KOLAY KULLANIM



## Darbelere dayanıklı

Franke granit kırılmaz ve ağır cisimlerin darbesinden sonra bile çatlamaz.



## Çizilmelere dayanıklı

Granit evyeler çizik riski bile taşımadan daima yeni gibi kalırlar.



## Sıvı emmeyen yüzeyler

Yüzeyi emici olmadığından, Fraganit lekelerle karşı da dayanıklıdır ve yağ, yağlı madde vs. ile temas halinde bile bozulma riski yoktur.



## Isıya dayanıklı

Franke granit 280°'ye kadar olan sıcaklıklara dirençli olup, görünümünü zaman içinde kaybetmez.



## Temizlemesi kolay

## DuraKleen®

Son derece pürüzsüz olmasını ve dokunulduğunda hoş bir his bırakmasını sağlayan özel Durakleen yüzeyi sayesinde, Fraganit'in temizlenmesi son derece kolaydır.



## Hijyenik

Özel Sanitized hijyen fonksiyonu sayesinde, eviye 24 saat korunur ve çok daha hijyenik olur. Bakteri ve mikrop üremesi %99 oranında engellenir.





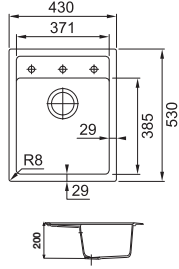

SID 610-40  
SID 610-40  
SID 610-40

Grafite  
Bianco  
Avena



114.0479.149  
114.0479.141  
114.0479.148

Montaj tipi  
Ebat  
Montaj ölçüsü  
Birlikte verilen bağlantı  
Alt Dolap ölçüsü

Tezgah Üstü  
430 x 530 mmmm  
410 x 510 mm  
112.0155.038  
Minimum 45 cm

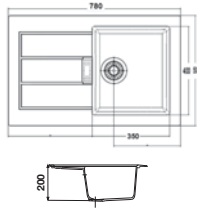

SID 611  
SID 611  
SID 611

Grafite  
Bianco  
Avena



114.0176.563  
114.0254.943  
114.0254.944

Montaj tipi  
Ebat  
Montaj ölçüsü  
Birlikte verilen bağlantı  
Alt Dolap ölçüsü

Tezgah Üstü  
780x500 mm  
760x480 mm  
112.0155.038  
Minimum 45 cm

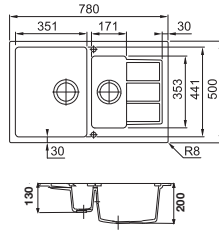

SID 651-78  
SID 651-78  
SID 651-78

Grafite  
Bianco  
Avena



114.0479.059  
114.0479.051  
114.0479.058

Montaj tipi  
Ebat  
Montaj ölçüsü  
Birlikte verilen bağlantı  
Alt Dolap ölçüsü

Tezgah Üstü  
780 x 500 mm  
760 x 480 mm  
112.0155.039  
Minimum 60 cm

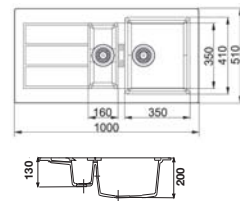

SID 651  
SID 651  
SID 651

Grafite  
Bianco  
Avena



114.0059.880  
114.0254.584  
114.0059.878

Montaj tipi  
Ebat  
Montaj ölçüsü  
Birlikte verilen bağlantı  
Alt Dolap ölçüsü

Tezgah Üstü  
1000x510 mm  
980x490 mm  
112.0155.039  
Minimum 60 cm

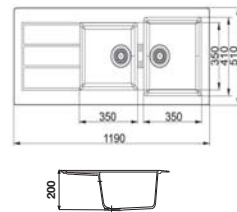

SID 621  
SID 621  
SID 621

Grafite  
Bianco  
Avena



114.0059.887  
114.0254.585  
114.0060.351

Montaj tipi  
Ebat  
Montaj ölçüsü  
Birlikte verilen bağlantı  
Alt Dolap ölçüsü

Tezgah Üstü  
1190x510 mm  
1170x490 mm  
112.0155.039  
Minimum 80 cm







# KUBUS TEZGAHALTI GRANİT

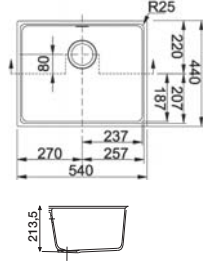

KBG 110-50  
KBG 110-50  
KBG 110-50  
KBG 110-50

**Grafite** 125.0068.576  
**Nero** 125.0159.335  
**Bianco** 125.0156.782  
**Avena** 125.0068.574

Montaj tipi  
Ebat  
Montaj ölçüsü  
Birlikte verilen bağlantı

Tezgah Altı  
500x400 mm  
Kutuların içinde şablon mevcuttur  
133.0050.083 - 112.0049.409  
klips 133.0172.567, sifon 112.0048.206,  
silikon 112.0069.756  
Minimum 60 cm

Alt Dolap ölçüsü

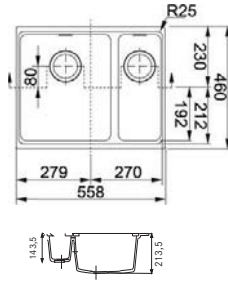

KBG 160  
KBG 160  
KBG 160  
KBG 160

**Grafite** 125.0157.335  
**Nero** 125.0159.337  
**Bianco** 125.0155.622  
**Avena** 125.0068.578

Montaj tipi  
Ebat  
Montaj ölçüsü  
Birlikte verilen bağlantı

Tezgah Altı  
528x400 mm  
Kutuların içinde şablon mevcuttur  
112.0049.409 - 112.0049.406  
112.0284.457, sifon 112.0048.209  
silikon 112.0069.756, klips 133.0172.567  
Minimum 60 cm

Alt Dolap ölçüsü

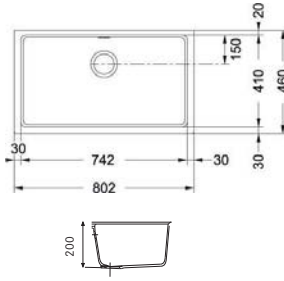

KBG 110-70  
KBG 110-70  
KBG 110-70  
KBG 110-70

**Grafite** 125.0205.771  
**Nero** 125.0250.193  
**Bianco** 125.0205.768  
**Avena** 125.0250.192

Montaj tipi  
Ebat  
Montaj ölçüsü  
Birlikte verilen bağlantı

Tezgah Altı  
742x410 mm  
Kutuların içinde şablon mevcuttur  
133.0050.083 - 112.0049.409  
sifon 112.0048.206, silikon 112.0069.756  
Minimum 90 cm

Alt Dolap ölçüsü





YENİ

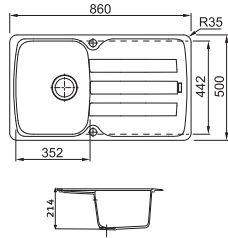

AZG 611-86

AZG 611-86

AZG 611-86

AZG 611-86

AZG 611-86

Grafite

Nero

Bianco

Avena

Sahara

	114.0470.452
	114.0470.454
	114.0470.457
	114.0470.453
	114.0469.748

Montaj tipi

Ebat

Montaj ölçüsü

Birlikte verilen bağlantı

Alt Dolap ölçüsü

Tezgah Üstü

860x500 mm

840x480 mm

112.0158.346, sifon 112.0068.243

silikon 112.0069.756

Minimum 45 cm



YENİ

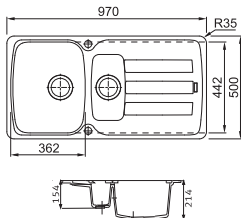

AZG 651

AZG 651

AZG 651

AZG 651

AZG 651

Grafite

Nero

Bianco

Avena

Sahara

	114.0470.463
	114.0470.465
	114.0470.468
	114.0470.464
	114.0470.461

Montaj tipi

Ebat

Montaj ölçüsü

Birlikte verilen bağlantı

Alt Dolap ölçüsü

Tezgah Üstü

970x500 mm

950x480 mm

112.0158.343, sifon 112.0048.209

silikon 112.0069.756

Minimum 60 cm



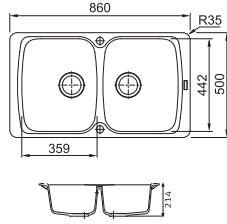

**AZG 620**  
**AZG 620**  
**AZG 620**  
**AZG 620**  
**AZG 620**

**Grafite** 114.0474.950  
**Nero** 114.0474.972  
**Bianco** 114.0474.975  
**Avena** 114.0474.971  
**Sahara** 114.0474.948

**Montaj tipi** Tezgah Üstü  
**Ebat** 860x500 mm  
**Montaj ölçüsü** 840x480 mm  
**Birlikte verilen bağlantı** 112.0158.243, sifon 112.0048.209  
silikon 112.0069.756  
**Alt Dolap ölçüsü** Minimum 80 cm

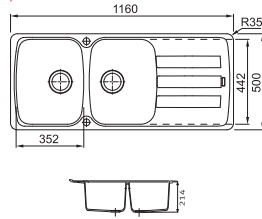

**AZG 621**  
**AZG 621**  
**AZG 621**  
**AZG 621**  
**AZG 621**

**Grafite** 114.0470.484  
**Nero** 114.0470.486  
**Bianco** 114.0470.489  
**Avena** 114.0470.485  
**Sahara** 114.0470.482

**Montaj tipi** Tezgah Üstü  
**Ebat** 1160x500 mm  
**Montaj ölçüsü** 1140x480 mm  
**Birlikte verilen bağlantı** 112.0158.343, sifon 112.0048.209  
silikon 112.0069.756  
**Alt Dolap ölçüsü** Minimum 80 cm



## GRANİT KÖŞE

### Antea Köşe

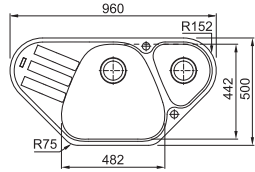

**AZG 661-E**  
**AZG 661-E**  
**AZG 661-E**  
**AZG 661-E**  
**AZG 661-E**

**Grafite** 114.0477.988  
**Nero** 114.0477.990  
**Bianco** 114.0477.992  
**Avena** 114.0477.989  
**Sahara** 114.0477.986

**Montaj tipi** Tezgah Üstü  
**Ebat** 960x500 mm  
**Montaj ölçüsü** Kutuların içinde şablon mevcuttur.  
**Birlikte verilen bağlantı** 112.0484.800, sifon 112.0048.203  
silikon 112.0069.756  
**Alt Dolap ölçüsü** 45° Köşe

### Yarım Hazne Süzgeci

112.0464.522



## ANTEA KÖŞE'YE DAHİL AKSESUAR

### Summit Köşe

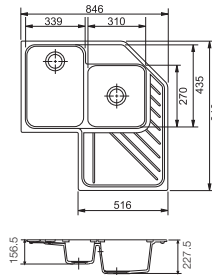

**SRG 612**  
**SRG 612**  
**SRG 612**

**Grafite** 114.0277.269  
**Bianco** 114.0158.700  
**Avena** 114.0027.036

**Montaj tipi** Tezgah Üstü  
**Ebat** 846x846x516 mm  
**Montaj ölçüsü** Kutuların içinde şablon mevcuttur.  
**Birlikte verilen bağlantı** 112.0158.343, sifon 112.0048.209  
silikon 112.0069.756  
**Alt Dolap ölçüsü** 90° Köşe





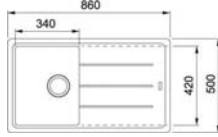

BFG 611-86  
BFG 611-86  
BFG 611-86  
BFG 611-86  
BFG 611-86

**Grafite** 114.0334.154  
**Nero** 114.0334.155  
**Bianco** 114.0334.125  
**Sahara** 114.0334.127  
**Avena** 114.0334.128

Montaj tipi  
Ebat  
Montaj ölçüsü  
Birlikte verilen bağlantı  
Alt Dolap ölçüsü

Tezgah Üstü  
860x500 mm  
840x480 mm  
112.0158.346, sifon 112.0068.243  
silikon 112.0069.756  
Minimum 45 cm

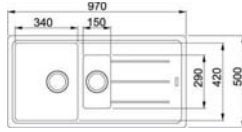

BFG 651  
BFG 651  
BFG 651  
BFG 651  
BFG 651

**Grafite** 114.0198.873  
**Nero** 114.0198.876  
**Bianco** 114.0198.878  
**Sahara** 114.0198.871  
**Avena** 114.0198.875

Montaj tipi  
Ebat  
Montaj ölçüsü  
Birlikte verilen bağlantı  
Alt Dolap ölçüsü

Tezgah Üstü  
970x500 mm  
950x480 mm  
112.0158.343, sifon 112.0048.209  
silikon 112.0069.756  
Minimum 60 cm

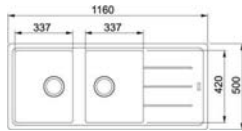

BFG 621  
BFG 621  
BFG 621  
BFG 621  
BFG 621

**Grafite** 114.0198.894  
**Nero** 114.0198.898  
**Bianco** 114.0198.900  
**Sahara** 114.0198.891  
**Avena** 114.0198.896

Montaj tipi  
Ebat  
Montaj ölçüsü  
Birlikte verilen bağlantı  
Alt Dolap ölçüsü

Tezgah Üstü  
1160x500 mm  
1140x480 mm  
112.0158.343, sifon 112.0048.209  
silikon 112.0069.756  
Minimum 80 cm



Çelik Esnek  
Süzgeç

112.0030.882

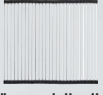

Maris granit Serisi tüm modeller ile  
uyumludur.  
**opsiyoneldir**



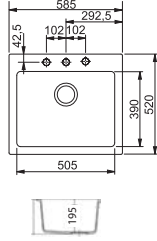

MRG 610-58  
MRG 610-58  
MRG 610-58  
MRG 610-58  
MRG 610-58

**Grafite** 114.0075.390  
**Nero** 114.0176.610  
**Bianco** 114.0079.802  
**Sahara** 114.0075.391  
**Avena** 114.0075.389

Montaj tipi  
Ebat  
Montaj ölçüsü  
Birlikte verilen bağlantı  
Alt Dolap ölçüsü

Tezgah Üstü  
585x520 mm  
Kutuların içinde şablon mevcuttur.  
112.0079.766, sifon 112.0006.456  
Minimum 60 cm

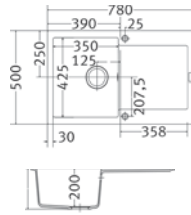

MRG 611  
MRG 611  
MRG 611  
MRG 611  
MRG 611

**Grafite** 114.0055.853  
**Nero** 114.0152.494  
**Bianco** 114.0061.682  
**Sahara** 114.0055.882  
**Avena** 114.0055.883

Montaj tipi  
Ebat  
Montaj ölçüsü  
Birlikte verilen bağlantı  
Alt Dolap ölçüsü

Tezgah Üstü  
780x500 mm  
760x480 mm  
112.0158.346, sifon 112.0068.243  
silikon 112.0069.756  
Minimum 45 cm

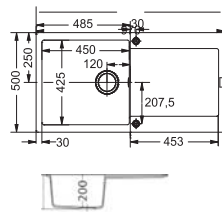

MRG 611-L  
MRG 611-L  
MRG 611-L  
MRG 611-L  
MRG 611-L

**Grafite** 114.0330.888  
**Nero** 114.0330.889  
**Bianco** 114.0330.857  
**Sahara** 114.0330.872  
**Avena** 114.0330.882

Montaj tipi  
Ebat  
Montaj ölçüsü  
Birlikte verilen bağlantı  
Alt Dolap ölçüsü

Tezgah Üstü  
970x500 mm  
950x480 mm  
112.0158.346, sifon 112.0048.206  
silikon 112.0069.756  
Minimum 60 cm

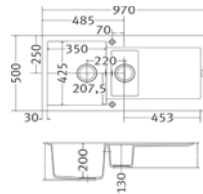

MRG 651  
MRG 651  
MRG 651  
MRG 651  
MRG 651

**Grafite** 114.0061.388  
**Nero** 114.0152.496  
**Bianco** 114.0061.393  
**Sahara** 114.0061.536  
**Avena** 114.0061.741

Montaj tipi  
Ebat  
Montaj ölçüsü  
Birlikte verilen bağlantı  
Alt Dolap ölçüsü

Tezgah Üstü  
970x500 mm  
950x480 mm  
112.0158.343, sifon 112.0048.209  
silikon 112.0069.756  
Minimum 60 cm





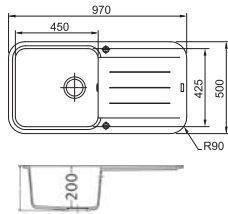

PBG 611  
PBG 611  
PBG 611  
PBG 611  
PBG 611

**Grafite**  
**Nero**  
**Bianco**  
**Sahara**  
**Avena**

	114.0200.429
	114.0200.443
	114.0200.453
	114.0200.427
	114.0200.441

**Montaj tipi**  
**Ebat**  
**Montaj ölçüsü**  
**Birlikte verilen bağlantı**  
**Alt Dolap ölçüsü**

Tezgah Üstü  
970x500 mm R90  
950x480 - R80  
112.0158.346, sifon 112.0068.243  
silikon 112.0069.756  
Minimum 60 cm

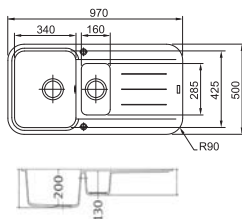

PBG 651  
PBG 651  
PBG 651  
PBG 651  
PBG 651

**Grafite**  
**Nero**  
**Bianco**  
**Sahara**  
**Avena**

	114.0200.473
	114.0200.476
	114.0200.506
	114.0200.471
	114.0200.475

**Montaj tipi**  
**Ebat**  
**Montaj ölçüsü**  
**Birlikte verilen bağlantı**  
**Alt Dolap ölçüsü**

Tezgah Üstü  
970x500 mm R90  
950x480 - R80  
112.0158.343, sifon 112.0048.209  
silikon 112.0069.756  
Minimum 60 cm



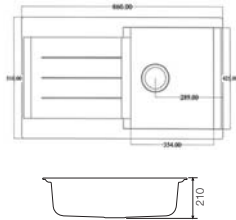

JAG 611  
JAG 611  
JAG 611  
JAG 611  
JAG 611

**Grafite** 114.0055.758  
**Nero** 114.0181.602  
**Bianco** 114.0075.810  
**Sahara** 114.0075.797  
**Avena** 114.0087.289

Montaj tipi  
Ebat  
Montaj ölçüsü  
Birlikte verilen bağlantı  
Alt Dolap ölçüsü

Tezgah Üstü  
860x510 mm  
840x490 mm  
Sifon 60004314  
Silikon 112.0069.756  
Minimum 45 cm

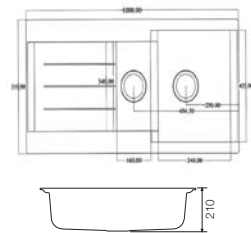

JAG 651  
JAG 651  
JAG 651  
JAG 651  
JAG 651

**Grafite** 114.0074.668  
**Nero** 114.0167.068  
**Bianco** 114.0074.670  
**Sahara** 114.0075.817  
**Avena** 114.0057.014

Montaj tipi  
Ebat  
Montaj ölçüsü  
Birlikte verilen bağlantı  
Alt Dolap ölçüsü

Tezgah Üstü  
1000x510 mm  
980x490 mm  
Sifon 60004326, silikon 112.0069.756  
Minimum 60 cm



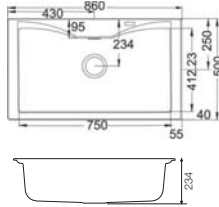

ACG 610-N-A

ACG 610-N-A

ACG 610-N-A

Grafite

Bianco

Avena



114.0185.316



114.0185.319



114.0185.318

Montaj tipi

Ebat

Montaj ölçüsü

Birlikte verilen bağlantı

Alt Dolap ölçüsü

Tezgah Üstü

860x500 mm

840x480 mm

112.0158.346, sifon 112.0068.243

silikon 112.0069.756

Minimum 90 cm

Aksesuarlar dahildir.



ACQUARIO'YA  
DAHİL AKSESUARLAR

Çelik Yarım Hazne  
Süzgeci

112.0040.691



Ahşap Kesme  
Tahtası

112.0176.753



Çelik Tel Sepet

112.0203.836





SYG 611

Alabaster white



114.0484.576

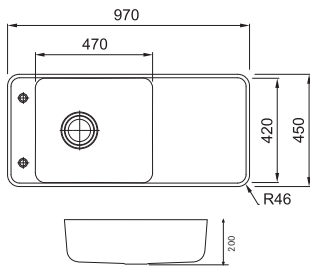

**Montaj tipi**  
**Ebat**  
**Montaj ölçüsü**  
**Birlikte verilen bağlantı**

Tezgah Üstü  
970 x 450 mm  
Kutu içerisinde şablon mevcuttur.  
112.0307.018,  
112.0480.588,133.0336.625,  
133.0050.083, sifon 112.0068.243  
133.0391.835  
Minimum 60 cm

**Alt Dolap ölçüsü**

Push button sifon kumandalıdır.  
Aksesuarlar dahildir.



STYLE'A  
DAHİL AKSESUARLAR

Ahşap Kesme  
Tahtası

112.0482.139



Çok Yönlü  
Kase

112.0482.140





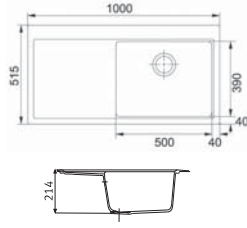

MTF 611 SOL  
MTF 611 SAĞ  
MTF 611 SOL  
MTF 611 SAĞ

Bianco 114.0157.003  
Bianco 114.0157.244  
Nero 114.0157.264  
Nero 114.0157.287

Montaj tipi  
Ebat  
Montaj ölçüsü  
Birlikte verilen bağlantı  
Alt Dolap ölçüsü

Tezgah Üstü  
1000x515 mm  
980x495 mm  
112.0190.132, sifon 112.0068.243  
Minimum 60 cm

Sifon kumandalıdır.  
Aksesuarlar dahildir.

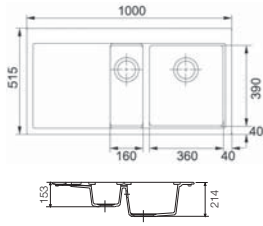

MTF 651 SOL  
MTF 651 SAĞ  
MTF 651 SOL  
MTF 651 SAĞ

Bianco 114.0156.977  
Bianco 114.0156.988  
Nero 114.0156.981  
Nero 114.0156.992

Montaj tipi  
Ebat  
Montaj ölçüsü  
Birlikte verilen bağlantı  
Alt Dolap ölçüsü

Tezgah Üstü  
1000x515 mm  
980x495 mm  
112.0190.133, sifon 112.0068.243  
Minimum 60 cm

Sifon kumandalıdır.  
Aksesuarlar dahildir.



## MYTHOS FUSION'A DAHİL AKSESUARLAR

Cam Kesme  
Tahtası

112.0017.900



Yarım Hazne  
Süzgeci

112.0057.817

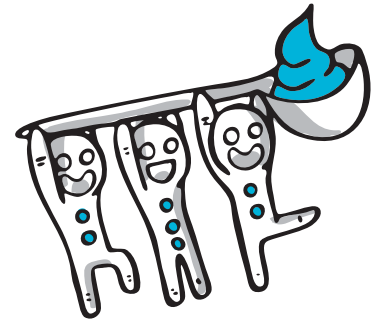

# ARMATÜRLER



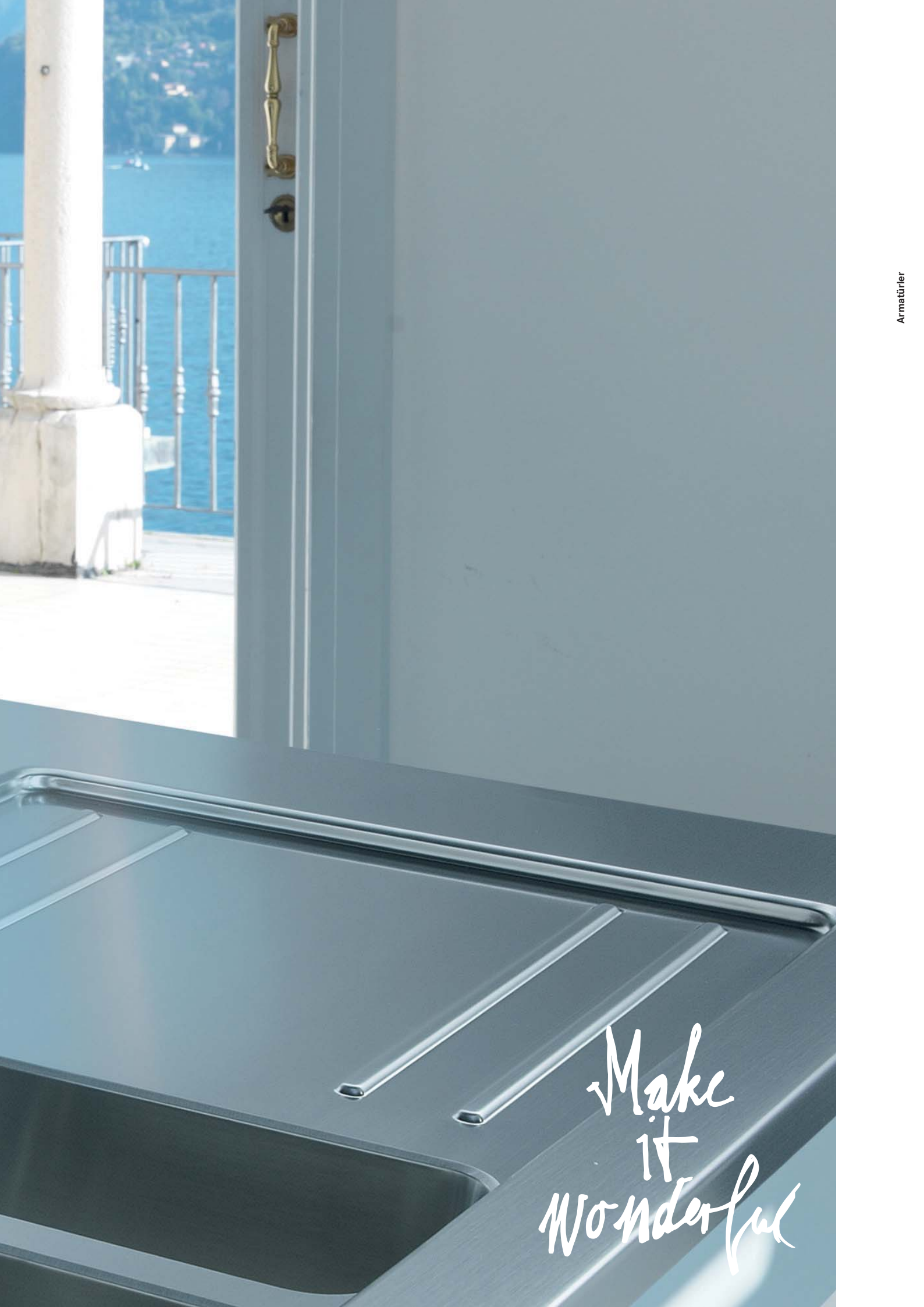

Make  
it  
Wonderful



# FRANKE ARMATÜRÜNÜ SEÇ

Modern ve klasik her tarza hitap eden farklı tasarımlara sahip geniş ürün gamı ile Franke Armatürler eviyelerin en profesyonel iş ortağı.

## ■ Tasarım uyumu

Eviye ile aynı model ismine sahip Franke armatürler eviye konseptini birebir tamamlarken, farklı seri ismine sahip armatürler de aynı uyuma sahiptir.



## ■ Yüzey ve renk alternatifleri

Franke armatür serisi yüzey ve renk açısından oldukça geniş bir yelpazeye sahiptir. Mutfak sistemi ile kusursuz dengenin sağlanması için krom, çelik, dore, bronz ve granit eviyelerle uyumlu renklerde alternatifler seçimide kolaylaştırır.

## ■ 28 mm'lik yeni kartuş



Su tasarrufu:

Çift kademeli sistem orta bir açılma akışından tam akışa geçmeye izin vererek su tüketimini azaltır.

Çocuk emniyeti:

Sıcaklığı ayarlama sistemi olası haşlanmalara karşı koruma sağlamaya izin verir.



## ■ Ergonomik spiraller

Eviyenin her noktasına suyun ulaşmasını sağlayan spiraller sayesinde hazne ve damlalıklar kolaylıkla temizlenir.



## ■ Duş akışı

El duşlarında bulunan püskürtme özelliği duş akışı sağlayarak sebze ve meyvelerin daha detaylı yıkanmasını sağlar



## ■ Hareketli el duşları

55-360° arası dönebilen su çıkış boruları ve hareketli el duşları ile yıkama işlemleri çok daha pratik hale gelir.



## ■ Seramik kartuş

Franke armatürlerin tamamında bulunan seramik disk ve seramik kartuşlar sayesinde suyun daha sessiz akması sağlanır.







# ARMATÜRLER

TURCHESE / PLATINO / CARY / CARY ANGOLA	92
GALILEO / RIVER / DIAMENTE	93
SMART	94
MATRIX	95
AMBIENT	96
NEPTUN EVO	97
ACTIVE PLUS	98
MARIS PLUS DOCCIA	99
FORMAT / LOUNGE / CAPRICE / PLANARIO	100
SINOS / ESPRIT / PESCARA	101

## EĞİLEBİLEN ARMATÜRLER

NEPTUN STYLE / ACTIVE / OLD ENGLAND	102-103
-------------------------------------	---------

## YARI PROFESYONEL ARMATÜRLER

LOUNGE / JOY COCTAIL / FOX PRO	104
PLANAR 8 FLEX / PESCARA / OVERSIZE	105

## KLASİK ARMATÜRLER

TICO / GRANITO / PLATINO / ACTIVE	106-107
OLD ENGLAND	108
OLD ENGLAND DOCCIA / AMBRA	109

## ÇELİK ARMATÜRLER

TAROS / EOS / ATLAS / CENTINOX	110-111
--------------------------------	---------



# TURCHESE / PLATINO / CARY ARCO / CARY ANGOLA

Turchese

Krom



115.0027.748

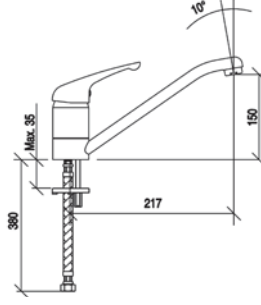

Tip  
Kartuş  
Hareket  
Bağlantı

Tek kumandalı  
Seramik diskli  
360° dönebilen su çıkış borusu  
Çelik örgü, esnek tesisat bağlantı boruları

Platino

Krom



115.0029.586

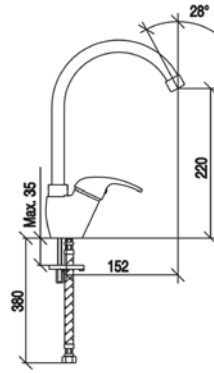

Tip  
Kartuş  
Hareket  
Bağlantı

Tek kumandalı  
Seramik diskli  
360° dönebilen su çıkış borusu  
Çelik örgü, esnek tesisat bağlantı boruları

Cary Arco

Krom



115.0155.390

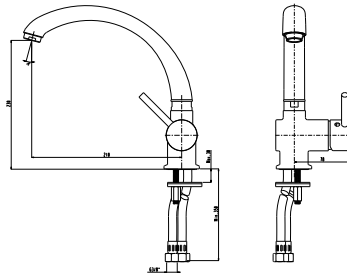

Tip  
Kartuş  
Hareket  
Bağlantı

Tek kumandalı  
Seramik diskli  
360° dönebilen su çıkış borusu  
Çelik örgü, esnek tesisat bağlantı boruları

Cary Angola

Krom



115.0255.072

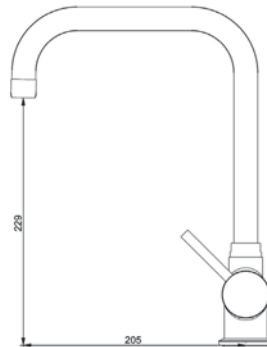

Tip  
Kartuş  
Hareket  
Bağlantı

Tek kumandalı  
Seramik diskli  
360° dönebilen su çıkış borusu  
Çelik örgü, esnek tesisat bağlantı boruları

# GALILEO / RIVER / DIAMENTE

## Galileo

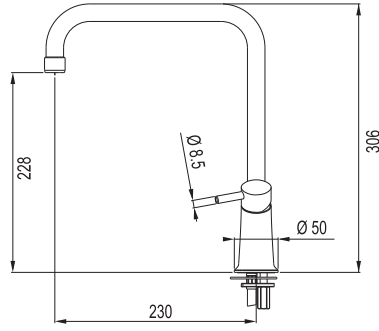

Krom



115.0196.552

Tip  
Kartuş  
Hareket  
Bağlantı

Tek kumandalı  
Seramik diskli  
360° dönebilen su çıkış borusu  
Çelik örgü, esnek tesisat bağlantı boruları

Armatürler

## River

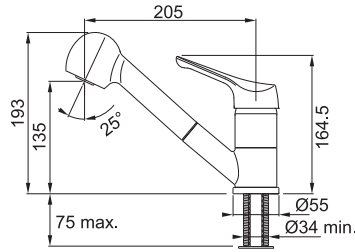

Krom



115.0263.174

Tip  
Spiral  
El duşu  
Kartuş  
Hareket  
Bağlantı

Tek kumandalı  
Çıkarılabilen metal spiral  
Su yoğunluk kontrolü, duş akışı  
Seramik diskli  
120° dönebilen su çıkış borusu  
Çelik örgü, esnek tesisat bağlantı boruları

## Diamente Doccia

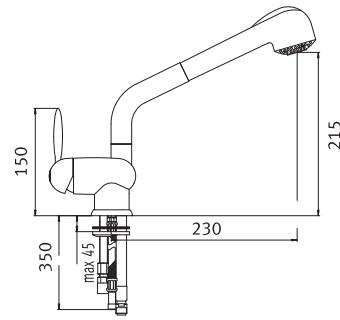

Krom



115.0029.584

Tip  
Spiral  
El duşu  
Kartuş  
Hareket  
Bağlantı

Tek kumandalı  
Çıkarılabilen metal spiral  
Su yoğunluk kontrolü, duş akışı  
Seramik diskli  
120° dönebilen su çıkış borusu  
Çelik örgü, esnek tesisat bağlantı boruları



## Smart

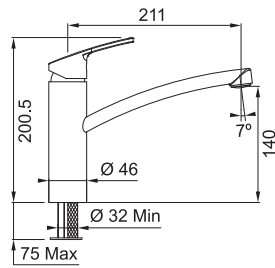

Krom



115.0391.460

Tip  
Kartuş  
Hareket  
Bağlantı

Tek kumandalı  
Seramik diskli  
360° dönebilen su çıkış borusu  
Çelik örgü, esnek tesisat bağlantı boruları

## Smart Doccia

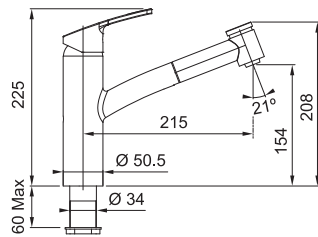

Krom



115.0391.482

Tip  
Spiral  
El duşu  
Kartuş  
Hareket  
Bağlantı

Tek kumandalı  
Çıkarılabilen metal spiral  
Su yoğunluk kontrolü, duş akışı  
Seramik diskli  
110° dönebilen su çıkış borusu  
Çelik örgü, esnek tesisat bağlantı boruları



Matrix

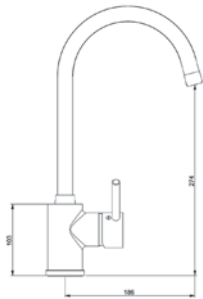

Krom



115.0029.625

Tip  
Kartuş  
Hareket  
Bağlantı

Tek kumandalı  
Seramik diskli  
360° dönebilen su çıkış borusu  
Çelik örgü, esnek tesisat bağlantı boruları

Matrix Doccia

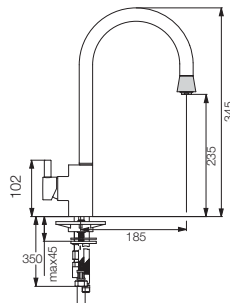

Krom



115.0029.626

Tip  
Spiral  
Kartuş  
Hareket  
Bağlantı

Tek kumandalı  
Çıkarılabilen metal spiral  
Seramik diskli  
120° dönebilen su çıkış borusu  
Çelik örgü, esnek tesisat bağlantı boruları



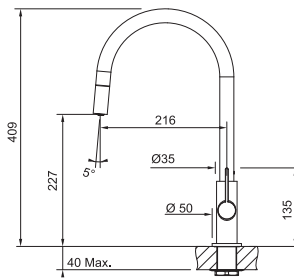

Krom



115.0373.947

Inox+Bianco



115.0373.949

Inox+Nero



115.0373.950

Tip  
Kartuş  
Hareket  
Bağlantı

Tek kumandalı  
Seramik diskli  
360° dönebilen su çıkış borusu  
Çelik örgü, esnek tesisat bağlantı boruları



Inox+Bianco



Inox+Nero

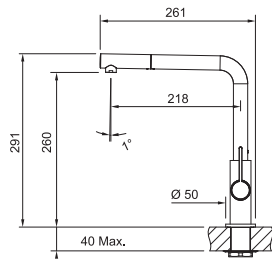

<b>Krom</b>		<b>115.0373.943</b>
<b>Inox+White</b>		<b>115.0373.944</b>
<b>Inox+Nero</b>		<b>115.0373.945</b>

<b>Tip</b>	Tek kumandalı
<b>Spiral</b>	Çıkarılabilen metal spiral
<b>Kartuş</b>	Seramik diskli
<b>Hareket</b>	360° dönebilen su çıkış borusu
<b>Bağlantı</b>	Çelik örgü, esnek tesisat bağlantı boruları



Inox+Nero



Inox+White

## Active Plus

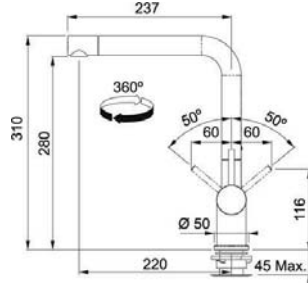

Krom



115.0373.790

Tip  
Kartuş  
Hareket  
Bağlantı

Tek kumandalı  
Seramik diskli  
360° dönebilen su çıkış borusu  
Çelik örgü, esnek tesisat bağlantı boruları

## Active Plus Doccia

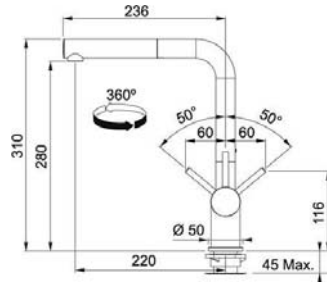

Krom



115.0373.770

Grafite



115.0373.890

Nero



115.0373.901

Bianco



115.0373.888

Sahara



115.0373.833

Avena







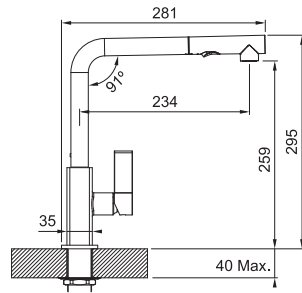

115.0373.884

Tip  
Spiral  
Kartuş  
Hareket  
Bağlantı

Tek kumandalı  
Çıkarılabilen metal spiral  
Seramik diskli  
360° dönebilen su çıkış borusu  
Çelik örgü, esnek tesisat bağlantı boruları





<b>Krom</b>		<b>115.0392.357</b>
<b>Inox+Grafite</b>		<b>115.0392.370</b>
<b>Inox+Nero</b>		<b>115.0392.382</b>
<b>Inox+Bianco</b>		<b>115.0392.368</b>
<b>Inox+Sahara</b>		<b>115.0392.360</b>
<b>Inox+Avena</b>		<b>115.0392.361</b>

<b>Tip</b>	Tek kumandalı
<b>Spiral</b>	Çıkarılabilen metal spiral
<b>El duşu</b>	El duşu altında su yoğunluk kontrolü, duş akışı
<b>Kartuş</b>	Seramik diskli
<b>Hareket</b>	360° dönebilen su çıkış borusu
<b>Bağlantı</b>	Çelik örgü, esnek tesisat bağlantı boruları



# FORMAT / LOUNGE / CAPRICE / PLANARIO

## Format

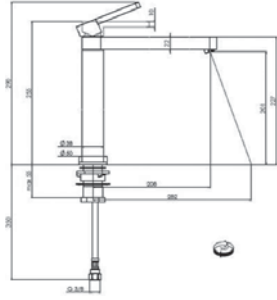

Krom



115.0177.751

Tip  
Kartuş  
Hareket  
Bağlantı

Tek kumandalı  
Seramik diskli  
120° dönebilen su çıkış borusu  
Çelik örgü, esnek tesisat bağlantı boruları

## Lounge

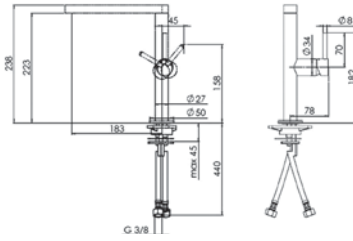

Krom



115.0177.748

Tip  
Kartuş  
Hareket  
Bağlantı

Tek kumandalı  
Seramik diskli  
360° dönebilen su çıkış borusu  
Çelik örgü, esnek tesisat bağlantı boruları

## Caprice Doccia

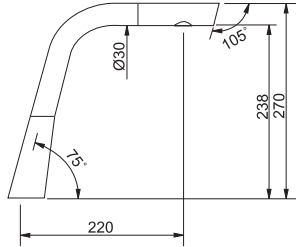

Krom



115.0177.700

Tip  
Spiral  
Kartuş  
Hareket  
Bağlantı

Tek kumandalı  
Çıkarılabilen metal spiral  
Seramik diskli  
360° dönebilen su çıkış borusu  
Çelik örgü, esnek tesisat bağlantı boruları

## Planario Tower

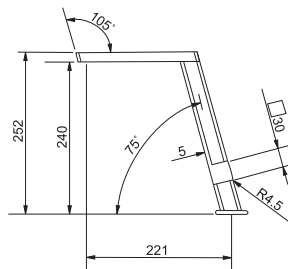

Krom



115.0177.697

Tip  
Kartuş  
Hareket  
Bağlantı

Tek kumandalı  
Seramik diskli  
360° dönebilen su çıkış borusu  
Çelik örgü, esnek tesisat bağlantı boruları



# EĞİLEBİLEN ARMATÜRLER / PENCERE ÖNÜ ÇÖZÜMLER



# NEPTUN STYLE / ACTIVE / OLD ENGLAND

## Neptün Style Window

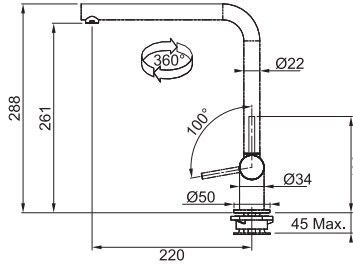

Krom



115.0263.158

Tip  
Kartuş  
Hareket  
Bağlantı  
Not

Tek kumandalı  
Seramik diskli  
360° dönebilen su çıkış borusu  
Çelik örgü, esnek tesisat bağlantı boruları  
Pencere önü kullanımlarda 90°  
öne eğilebilir



## Active Window

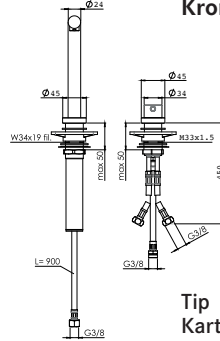
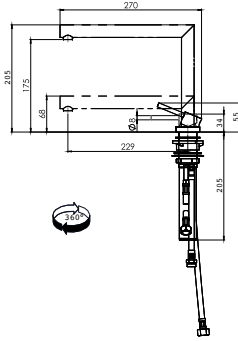

Krom



115.0486.980

Tip  
Kartuş  
Hareket  
Bağlantı  
Not

Tek kumandalı  
Seramik diskli  
360° dönebilen su çıkış borusu  
Çelik örgü, esnek tesisat bağlantı boruları  
Gövde yüksekliği ayarlanabilir, pencere önü  
kullanımları için çözüm sunar

## Active Window Doccia

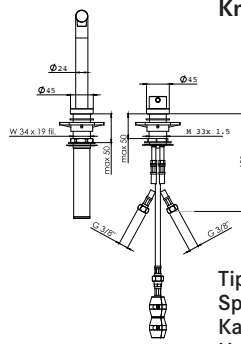
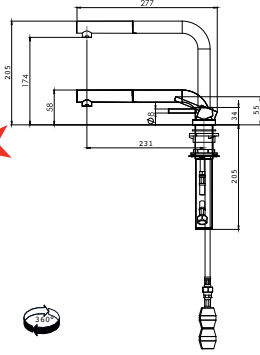

Krom



115.0486.978

Tip  
Spiral  
Kartuş  
Hareket  
Bağlantı  
Not

Tek kumandalı  
Çıkarılabilen metal spirale  
Seramik diskli  
360° dönebilen su çıkış borusu  
Çelik örgü, esnek tesisat bağlantı boruları  
Gövde yüksekliği ayarlanabilir, pencere önü  
kullanımları için çözüm sunar

## Old England Window

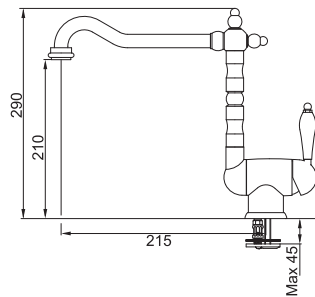

Bronz



115.0028.206

Copper



115.0028.207

Tip  
Hareket  
Bağlantı

Tek kumandalı  
360° dönebilen su çıkış borusu  
Çelik örgü, esnek tesisat bağlantı boruları



Copper



## Lounge Doccia

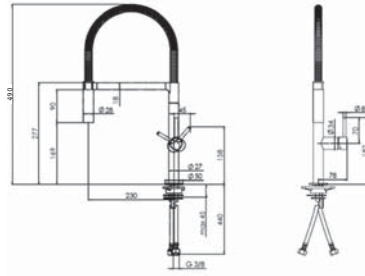

Krom



115.0177.706



Tip  
Spiral  
Kartuş  
Hareket  
Bağlantı

Tek kumandalı  
Çıkarılabilen helezon spiral  
Seramik diskli  
360° dönebilen su çıkış borusu  
Çelik örgü, esnek tesisat bağlantı boruları

## Joy Coctail

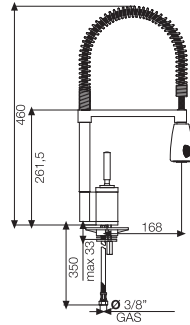

Krom



115.0029.591

Tip  
Spiral  
El duşu  
Kartuş  
Hareket  
Bağlantı

Tek kumandalı  
Çıkarılabilen helezon spiral  
Profesyonel kullanım için özel su çıkış ağzı  
Su yoğunluk kontrolü, duş akışı  
Seramik diskli  
360° dönebilen su çıkış borusu  
Çelik örgü, esnek tesisat bağlantı boruları

## Fox Pro

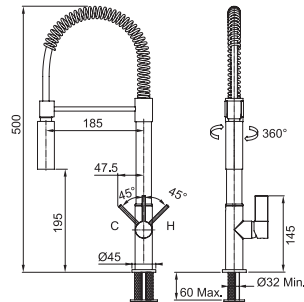

Krom



115.0486.993

Tip  
Spiral  
El duşu  
Kartuş  
Hareket  
Bağlantı

Tek kumandalı  
Çıkarılabilen helezon spiral  
Profesyonel kullanım için özel su çıkış ağzı  
Su yoğunluk kontrolü, duş akışı  
Seramik diskli  
360° dönebilen su çıkış borusu  
Çelik örgü, esnek tesisat bağlantı boruları

# YARI PROFESYONEL KULLANIM

# PLANAR 8 FLEX / PESCARA / OVERSIZE

Planar 8 Flex

Krom



115.0045.922

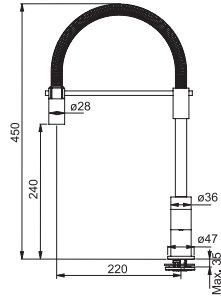

Tip  
Spiral  
El duşu  
Kartuş  
Hareket  
Bağlantı

Tek kumandalı  
Çıkarılabilen helezon spiral  
Profesyonel kullanım için özel su çıkış ağızı  
Seramik diskli  
360° dönebilen su çıkış borusu  
Çelik örgü, esnek tesisat bağlantı boruları

Armatürler

Pescara

Krom



115.0393.976

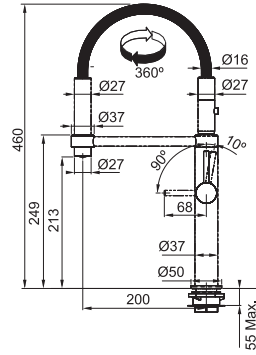

Tip  
Spiral  
Kartuş  
Hareket  
Bağlantı

Tek kumandalı  
Çıkarılabilen helezon spiral  
Seramik diskli  
360° dönebilen su çıkış borusu  
Çelik örgü, esnek tesisat bağlantı boruları

Akış yönü değiştirilebilir fonksiyonel başlık

Oversize

Krom



115.0196.526

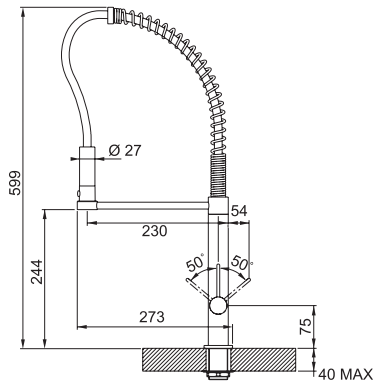

Tip  
Spiral  
El duşu  
Kartuş  
Hareket  
Bağlantı

Tek kumandalı  
Çıkarılabilen helezon spiral  
Profesyonel kullanım için özel su çıkış ağızı  
Su yoğunluk kontrolü, duş akışı  
Seramik diskli  
360° dönebilen su çıkış borusu  
Çelik örgü, esnek tesisat bağlantı boruları

# KLASİK ARMATÜRLER





## Old England

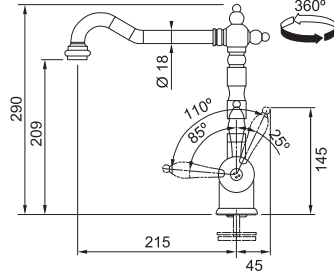

Krom  
Grafite  
Avena  
Dore  
Bronz  
Copper



115.0060.360  
115.0180.686  
115.0180.673  
115.0315.597  
115.0028.205  
115.0028.208

Tip  
Kartuş  
Hareket  
Bağlantı

Tek kumandalı  
Seramik diskli  
360° dönebilen su çıkış borusu  
Çelik örgü, esnek tesisat bağlantı boruları



Grafite



Avena



Dore



Bronz



Krom

## Old England

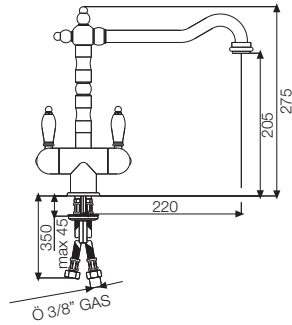

Grafite  
Avena  
Dore  
Bronz



115.0180.688  
115.0180.687  
115.0315.598  
115.0028.204

Tip  
Kartuş  
Hareket  
Bağlantı

Çift kumandalı  
Seramik diskli  
360° dönebilen su çıkış borusu  
Çelik örgü, esnek tesisat bağlantı boruları



Grafite



Avena



Dore

# OLD ENGLAND DOCCIA/ AMBRA

## Old England Doccia

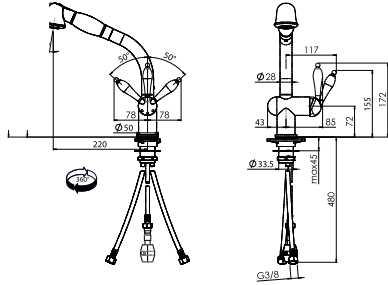

Krom



115.0378.607

Bronz



115.0378.606

Tip  
Spiral  
El duşu  
Hareket  
Bağlantı

Tek kumandalı  
Çıkarılabilen metal spiral  
Su yoğunluk kontrolü, duş akışı  
360° dönebilen su çıkış borusu  
Çelik örgü, esnek tesisat bağlantı boruları



Krom

Armatürler

## Ambra

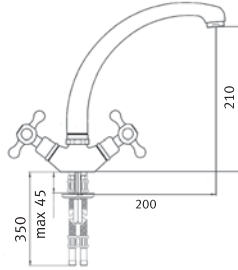

Dore



115.0182.622

Bronz



115.0028.190

Tip  
Hareket  
Bağlantı

Çift kumandalı  
360° dönebilen su çıkış borusu  
Çelik örgü, esnek tesisat bağlantı boruları



Bronz

# ÇELİK ARMATÜRLER



## Taros

Çelik



115.0047.987



AISI 304

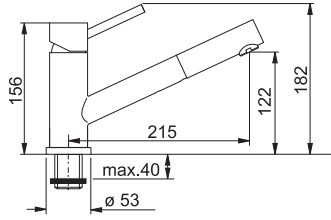

Tip  
Spiral  
Kartuş  
Hareket  
Bağlantı

Tek kumandalı  
Çıkarılabilen metal spiral  
Seramik diskli  
120° dönebilen su çıkış borusu  
Çelik örgü, esnek tesisat bağlantı boruları

## Eos

Çelik



115.0156.202



AISI 304

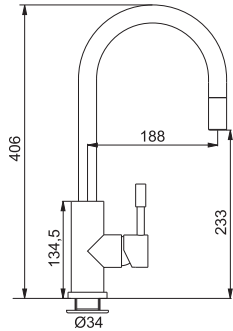

Tip  
Spiral  
Kartuş  
Hareket  
Bağlantı

Tek kumandalı  
Çıkarılabilen metal spiral  
Seramik diskli  
360° dönebilen su çıkış borusu  
Çelik örgü, esnek tesisat bağlantı boruları

## Atlas

Çelik



115.0156.201



AISI 304

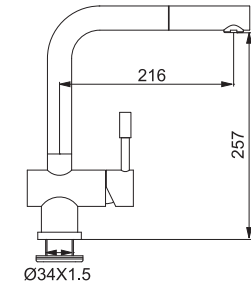

Tip  
Spiral  
Kartuş  
Hareket  
Bağlantı

Tek kumandalı  
Çıkarılabilen metal spiral  
Seramik diskli  
360° dönebilen su çıkış borusu  
Çelik örgü, esnek tesisat bağlantı boruları

## Centinox

Çelik



115.0177.709



AISI 304

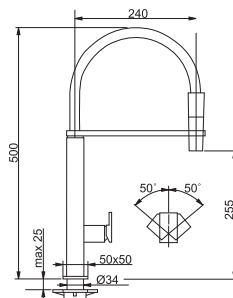

Tip  
Spiral  
Kartuş  
Hareket  
Bağlantı

Tek kumandalı  
Çıkarılabilen siyah helezon spiral  
Seramik diskli  
360° dönebilen su çıkış borusu  
Çelik örgü, esnek tesisat bağlantı boruları







# BANYO ARMATÜRLERİ & AKSESUARLAR

BANYO LAVABO ARMATÜRLERİ	116
DUŞ ARMATÜRLERİ	117
BANYO KÜVET / DUŞ ARMATÜRLERİ	118
ANKASTRE KONTROL ÜNİTELERİ	119
YÖNLENDİRİCİLİ ANKASTRE KONTROL ÜNİTELERİ	120
DUŞ SETLERİ	121
EL DUŞLARI	122
TEPE DUŞLARI	123
TEPE DUŞU BAĞLANTILARI	124
DUŞ VE BANYO AKSESUARLARI	125
HAVLU ASKILARI	126
ÇİFT HAVLU ASKILARI	127
ÇOKLU HAVLU RAFLARI	128
HAVLU KOLLARI / HALKA HAVLULUKLAR	129
DİŞ FIRÇALIKLAR	130
SABUNLUKLAR	131
ASKILAR	132
ÇİFT ASKI / ÇÖP KOVASI / SABUNLUK	133
TUVALET KAĞITLIKLARI	134
TUVALET FIÇALIKLARI	135

# BANYO ARMATÜR TEKNOLOJİLERİ





### FRANKE ECOFRESH

Su sıcaklığı limitleyici özelliği ile istenilen maximum seviyede su sıcaklığı sabitlenebilir.



### PARIGI PARINOX SOFTPEX

Hijyenik özellik sağlayan dayanıklı tesisat boruları.



### FRANKE ENERGYSAVING

Kumanda kolu merkez pozisyondayken soğuk su akışı sağlayarak gereksiz kombi çalışmasını engelleyerek enerji tasarrufu sağlar.



### FRANKE BRIGHT

Ürün yüzeyi son derece parlak krom kaplamadır.



### FRANKE WATERSAVING

Kademeli kumanda kolu sayesinde ilk seviyede %50 su tasarrufu, ikinci seviyede maximum su akışı sağlar.



### COOLBODY

Ürün yüzeyi suyun sıcaklığını dışa iletmez.



### FRANKE ECOPLASTIC

Kartuşlar insan sağlığına duyarlı olarak üretilmiştir.



### ATOMİZER

Yoğun veya düşük basınçlı ayarlanabilen su akış şekli.



### FRANKE LIVEDRIVE

Seramik diskler sayesinde düşük sürtünme ile hassas ve etkin su ısı değişimi sağlar.



### FRANKE WIDD

Suyun kireç ve kirden arınmasını sağlar.



### NEOPERL CASCADE

2 adet perlatör içerir. Bir perlatör 5 dk. su akış debisi ayarlarken, diğer perlatör armatürün kapasitesi kadar su akışı sağlar.



### SMARTFLEX

Hareket özgürlüğü sağlayan esnek duş hortumu.

## Medius

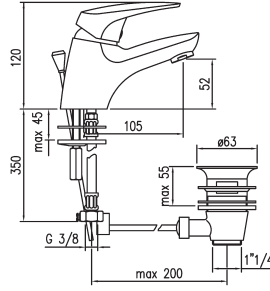

**MEDX118**

**2000106227**

Tek kumanda kolu  
Kireç tutmayan perlatör M 24x1  
Sifon tapası 1 1/4"  
ø 3/8" çelik esnek tesisat boruları  
Parlak krom yüzey  
Prinç ve minimum oranda kurşun içerir



## Firmus

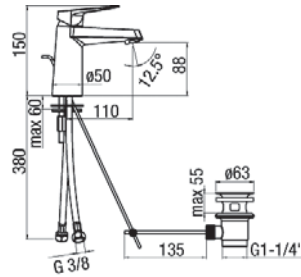

**FIRX118**

**2000106240**

Tek kumanda kolu  
Kireç tutmayan perlatör M 22x1  
Sifon tapası 1 1/4"  
ø 3/8" çelik esnek tesisat boruları  
Parlak krom yüzey  
Prinç ve minimum oranda kurşun içerir



## Venus

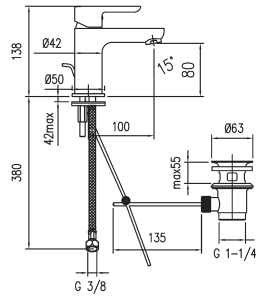

**VENX118**

**2000106198**

Tek kumanda kolu  
Kireç tutmayan perlatör M 24x1  
Sifon tapası 1 1/4"  
ø 3/8" çelik esnek tesisat boruları  
Parlak krom yüzey  
Prinç ve minimum oranda kurşun içerir

**ECO**



## Cubus

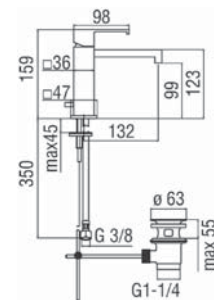

**CUBX118**

**2000106222**

Tek kumanda kolu  
Kireç tutmayan perlatör M 24x1  
Sifon tapası 1 1/4"  
ø 3/8" çelik esnek tesisat boruları  
Parlak krom yüzey  
Prinç ve minimum oranda kurşun içerir



## Medius

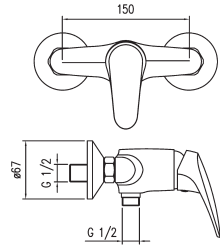

MEDX130

2000106229



Sıva üstü banyo duş armatürü  
Aks mesafesi 150 +/- 25  
ø 1/2" bağlantı noktası  
Parlak krom yüzey  
Prinç ve minimum oranda kurşun içerir

## Firmus

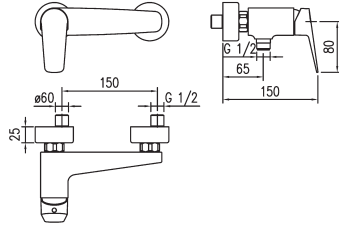

FIRX130

2000106236



Sıva üstü banyo duş armatürü  
Aks mesafesi 150 +/- 25  
ø 1/2" bağlantı noktası  
Parlak krom yüzey  
Prinç ve minimum oranda kurşun içerir

## Venus

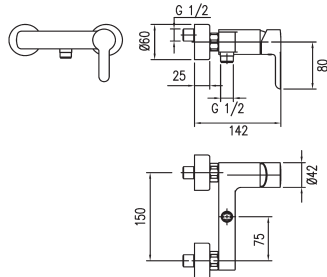

VENX130

2000106200



Sıva üstü banyo duş armatürü  
Aks mesafesi 150 +/- 20  
ø 1/2" bağlantı noktası  
Parlak krom yüzey  
Prinç ve minimum oranda kurşun içerir

## Cubus

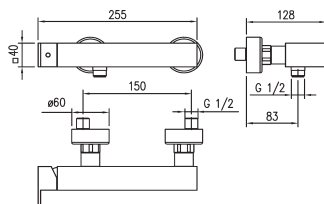

CUBX130

2000106223



Sıva üstü banyo duş armatürü  
Aks mesafesi 150 +/- 20  
ø 1/2" bağlantı noktası  
Parlak krom yüzey  
Prinç ve minimum oranda kurşun içerir

## Banyo Küvet/Duş Armatürü

### Medius

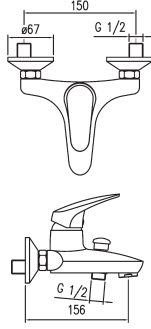

MEDX110

2000106226

Sıva üstü banyo küvet / duş armatürü  
Aks mesafesi 150 +/- 25  
Otomatik su yönlendirici  
Kireç tutmayan perlatör M 28x1  
Parlak krom yüzey  
Prinç ve minimum oranda kurşun içerir



### Firmus

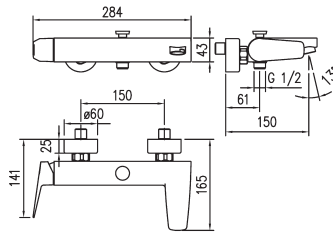

FIRX110

2000106239

Sıva üstü banyo küvet / duş armatürü  
Aks mesafesi 150 +/- 20  
Su yönlendirici  
Kireç tutmayan perlatör M 24x1  
Parlak krom yüzey  
Prinç ve minimum oranda kurşun içerir



### Venus

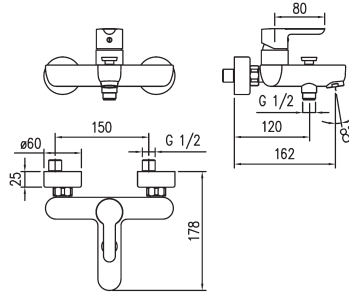

VENX110

2000106197

Sıva üstü banyo küvet / duş armatürü  
Aks mesafesi 150 +/- 25  
Otomatik su yönlendirici  
Kireç tutmayan perlatör M 28x1  
Parlak krom yüzey  
Prinç ve minimum oranda kurşun içerir



### Cubus

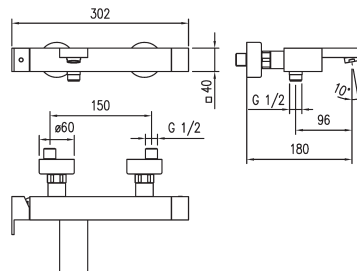

CUBX110

2000106221

Sıva üstü banyo küvet / duş armatürü  
Aks mesafesi 150 +/- 20  
Su yönlendirici  
Kireç tutmayan perlatör M 24x1  
Parlak krom yüzey  
Prinç ve minimum oranda kurşun içerir



# Ankastre Kontrol Ünitesi

## Medius

MEDX108

2000106225

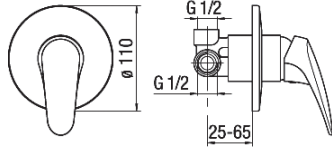

Ankastre kontrol ünitesi  
ø 1/2" bağlantı noktası  
Parlak krom yüzey  
Prinç ve minimum oranda kurşun içerir



## Firmus

FIRX108

2000106238

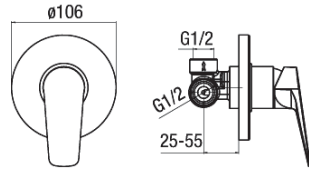

Ankastre kontrol ünitesi  
ø 1/2" bağlantı noktası  
Parlak krom yüzey  
Prinç ve minimum oranda kurşun içerir



## Venus

VENX108

2000106196

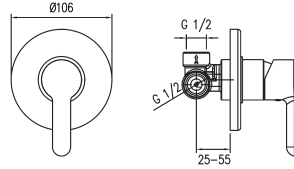

Ankastre kontrol ünitesi  
ø 1/2" bağlantı noktası  
Parlak krom yüzey  
Prinç ve minimum oranda kurşun içerir



## Cubus

CUBX108

2000106220

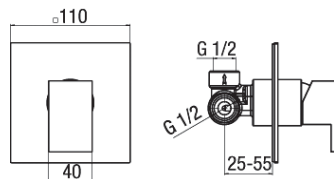

Ankastre kontrol ünitesi  
ø 1/2" bağlantı noktası  
Parlak krom yüzey  
Prinç ve minimum oranda kurşun içerir





# Tepe Duşu ve El Duşu Yönlendiricili Ankastre Kontrol Ünitesi

## Medius

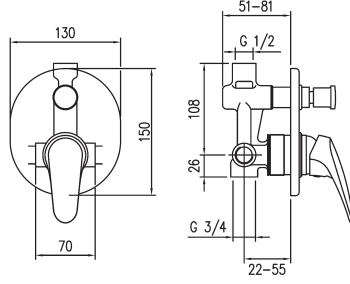

MEDX100

2000106224

Ankastre kontrol ünitesi  
Su yönlendirici  
Parlak krom yüzey  
Prinç ve minimum oranda kurşun içerir



## Firmus

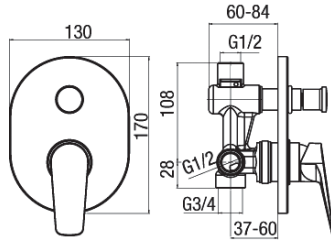

FIRX100

2000106237

Ankastre kontrol ünitesi  
Su yönlendirici  
Parlak krom yüzey  
Prinç ve minimum oranda kurşun içerir



## Venus

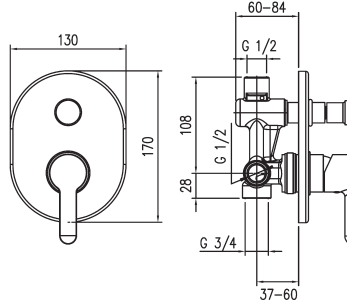

VENX100

2000106195

Ankastre kontrol ünitesi  
Su yönlendirici  
Parlak krom yüzey  
Prinç ve minimum oranda kurşun içerir



## Cubus

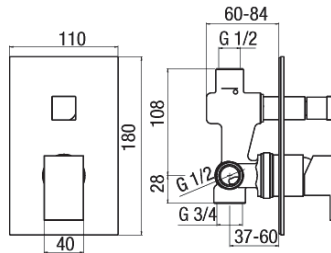

CUBX100

2000106219

Ankastre kontrol ünitesi  
Su yönlendirici  
Parlak krom yüzey  
Prinç ve minimum oranda kurşun içerir



## Medius

SHOX4023

2000106208

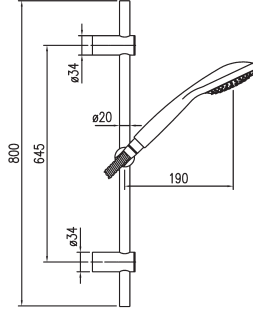

Sürgülü duvar askısı ve el duşu  
800 mm uzunluk  
Tek akış sunan el duşu  
1500 mm esnek duş hortumu  
Parlak krom yüzey  
Prinç ve minimum oranda kurşun içerir



## Firmus & Icarus

SHOX4034

2000106209

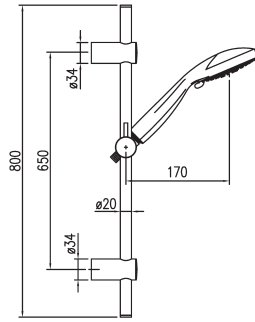

Sürgülü duvar askısı ve el duşu  
800 mm uzunluk  
3 farklı akış sunan el duşu  
1500 mm esnek duş hortumu  
Parlak krom yüzey  
Prinç ve minimum oranda kurşun içerir



## Venus & Cubus

SHOX4021

2000106207

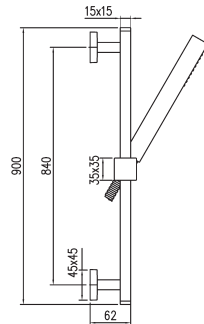

Sürgülü duvar askısı ve el duşu  
900 mm uzunluk  
Tek akış sunan el duşu  
1500 mm esnek duş hortumu  
Parlak krom yüzey  
Prinç ve minimum oranda kurşun içerir



## Medius & Firmus & Venus

SHOX1444

2000106210

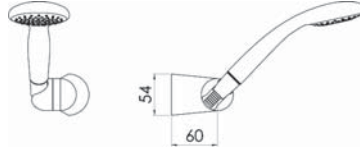

Tek akışlı el duşu  
Ayarlanabilir el duşu tutacağı  
1500 mm esnek duş hortumu  
Parlak krom yüzey  
Prinç ve minimum oranda kurşun içerir



## Icarus

SHOX4626

2000106214

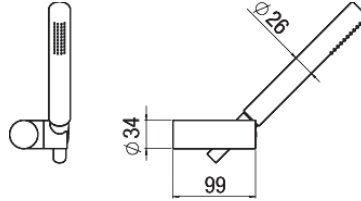

Tek akışlı el duşu  
Ayarlanabilir el duşu tutacağı  
1500 mm esnek duş hortumu  
Parlak krom yüzey  
Prinç ve minimum oranda kurşun içerir



## Cubus

SHOX4624

2000106213

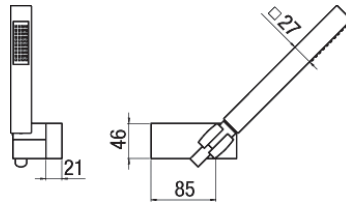

Tek akışlı el duşu  
Ayarlanabilir el duşu tutacağı  
1500 mm esnek duş hortumu  
Parlak krom yüzey  
Prinç ve minimum oranda kurşun içerir



Medius

SHOX39 10

2000106204

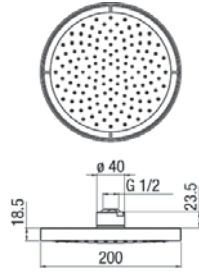

Ayarlanabilir tepe duşu  
ø 200 mm  
Kireç önleyici sistem  
Yağmur akışı  
Parlak krom yüzey  
Prinç ve minimum oranda kurşun içerir

Firmus & Icarus

SHOX3979

2000106206

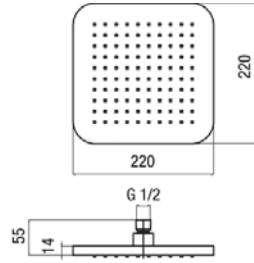
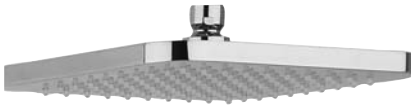

Ayarlanabilir tepe duşu  
ø 220 mm  
Kireç önleyici sistem  
Yağmur akışı  
Parlak krom yüzey  
Prinç ve minimum oranda kurşun içerir

Venus & Cubus

SHOX39 17

2000106205

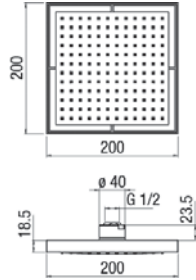

Ayarlanabilir tepe duşu  
ø 200 mm  
Kireç önleyici sistem  
Yağmur akışı  
Parlak krom yüzey  
Prinç ve minimum oranda kurşun içerir

## Tepe Duşu Bağlantısı

Medius

SHOX1384

2000106203

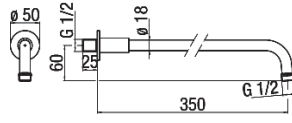

Tepe duşu bağlantısı  
350 mm uzunluk  
Parlak krom yüzey  
Prinç ve minimum oranda kurşun içerir

Firmus & Icarus

SHOX3843

2000106202

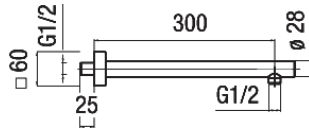

Tepe duşu bağlantısı  
350 mm uzunluk  
Parlak krom yüzey  
Prinç ve minimum oranda kurşun içerir

Venus & Cubus

SHOX3824

2000106201

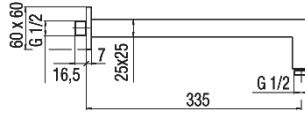

Tepe duşu bağlantısı  
350 mm uzunluk  
Parlak krom yüzey  
Prinç ve minimum oranda kurşun içerir

## Duř ve Banyo Aksesuarları

### Medius

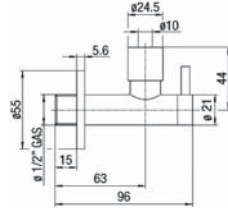

SHOX1213

2000106216

Filtreli ara musluk

### Firmus & Icarus

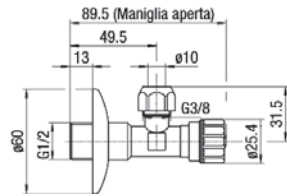

SHOX1212

2000106215

Filtreli ara musluk

### Venus & Cubus

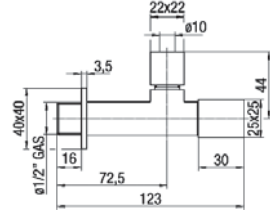

SHOX1214

2000106217

Filtreli ara musluk

### Medius

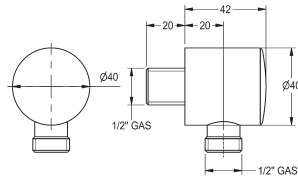

MEDX1501

2000110887

Hortum baęlantı noktası  
Duvar baęlantılı  
Parlak krom yzey

### Firmus & Icarus

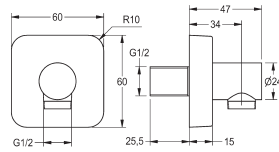

ICAX1501

2000110888

Hortum baęlantı noktası  
Duvar baęlantılı  
Parlak krom yzey

### Venus & Cubus

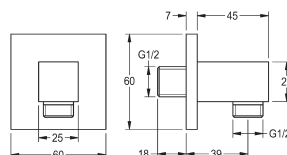

CUBX1503

2000110889

Hortum baęlantı noktası  
Duvar baęlantılı  
Parlak krom yzey

## Medius

<b>MEDX001</b>	<b>Mat</b>	<b>2000106242</b>
<b>MEDX001HP</b>	<b>Parlak</b>	<b>2000106243</b>

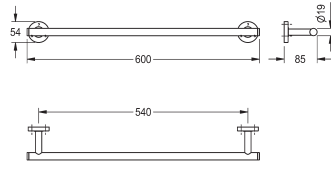

Duvar bağlantılı tekli havlu askısı  
304 kalite paslanmaz çelik  
Vidaları saklayabilen yuvarlak bağlantı noktaları  
SS vida ve tespit pimlerini içerir  
600x85x54 mm

## Firmus

<b>FIRX001</b>	<b>Mat</b>	<b>2000106264</b>
<b>FIRX001HP</b>	<b>Parlak</b>	<b>2000106265</b>

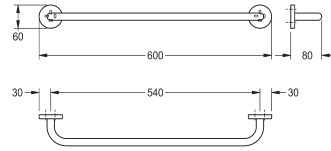

Duvar bağlantılı tekli havlu askısı  
304 kalite paslanmaz çelik  
Vidaları saklayabilen yuvarlak bağlantı noktaları  
SS vida ve tespit pimlerini içerir  
600x80x60 mm

## Venus

<b>VENX001</b>	<b>Mat</b>	<b>2000106322</b>
<b>VENX001HP</b>	<b>Parlak</b>	<b>2000106323</b>

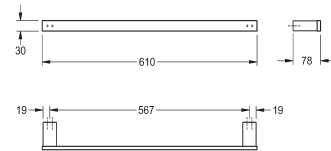

Duvar bağlantılı tekli havlu askısı  
304 kalite paslanmaz çelik  
Vidaları saklayabilen yuvarlak bağlantı noktaları  
SS vida ve tespit pimlerini içerir  
610x78x30 mm

## Cubus

<b>CUBX001</b>	<b>Mat</b>	<b>2000106344</b>
<b>CUBX001HP</b>	<b>Parlak</b>	<b>2000106345</b>

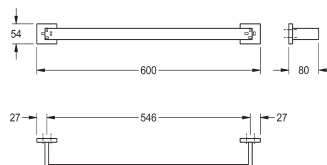

Duvar bağlantılı tekli havlu askısı  
304 kalite paslanmaz çelik  
Vidaları saklayabilen yuvarlak bağlantı noktaları  
SS vida ve tespit pimlerini içerir  
600x80x54 mm

## Çift Havlu Askısı

### Medius

<b>MEDX002</b>	<b>Mat</b>	<b>2000106244</b>
<b>MEDX002HP</b>	<b>Parlak</b>	<b>2000106245</b>

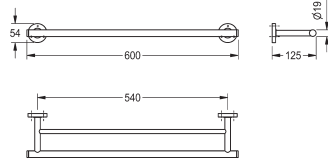

Duvar bağlantılı çiftli havlu askısı  
304 kalite paslanmaz çelik  
Sabitlemek için alttan delinmiş yuvarlak bağlantı noktaları SS vida ve tespit pimlerini içerir  
600x125x54 mm

### Firmus

<b>FIRX002</b>	<b>Mat</b>	<b>2000106266</b>
<b>FIRX002HP</b>	<b>Parlak</b>	<b>2000106267</b>

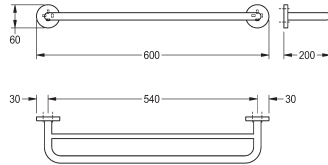

Duvar bağlantılı çiftli havlu askısı  
304 kalite paslanmaz çelik  
Sabitlemek için alttan delinmiş yuvarlak bağlantı noktaları SS vida ve tespit pimlerini içerir  
600x200x60 mm

### Venus

<b>VENX002</b>	<b>Mat</b>	<b>2000106324</b>
<b>VENX002HP</b>	<b>Parlak</b>	<b>2000106325</b>

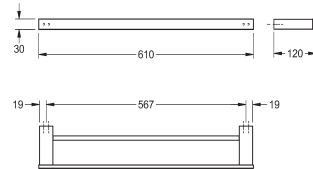

Duvar bağlantılı çiftli havlu askısı  
304 kalite paslanmaz çelik  
Sabitlemek için alttan delinmiş yuvarlak bağlantı noktaları SS vida ve tespit pimlerini içerir  
600x120x30 mm

### Cubus

<b>CUBX002</b>	<b>Mat</b>	<b>2000106346</b>
<b>CUBX002HP</b>	<b>Parlak</b>	<b>2000106347</b>

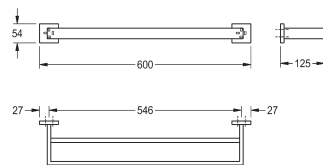
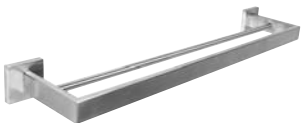

Duvar bağlantılı çiftli havlu askısı  
304 kalite paslanmaz çelik  
Sabitlemek için alttan delinmiş yuvarlak bağlantı noktaları SS vida ve tespit pimlerini içerir  
600x125x54 mm



# Çoklu Havlu Rafı

## Medius

<b>MEDX0 12</b>	<b>Mat</b>	<b>2000 106256</b>
<b>MEDX0 12HP</b>	<b>Parlak</b>	<b>2000 106257</b>

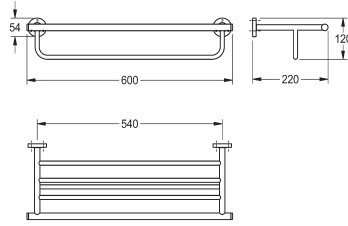

Duvar bağlantılı çoklu havlu rafı ve askı kombinasyonu  
304 kalite paslanmaz çelik  
Sabitlemek için alttan delinmiş yuvarlak bağlantı noktaları SS vida ve tespit pimlerini içerir  
600x220x120 mm

## Firmus

<b>FIRX0 12</b>	<b>Mat</b>	<b>2000 106280</b>
<b>FIRX0 12HP</b>	<b>Parlak</b>	<b>2000 106281</b>

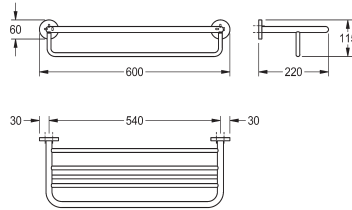

Duvar bağlantılı çoklu havlu rafı ve askı kombinasyonu  
304 kalite paslanmaz çelik  
Sabitlemek için alttan delinmiş yuvarlak bağlantı noktaları SS vida ve tespit pimlerini içerir  
600x220x115 mm

## Venus

<b>VENX3 12</b>	<b>Mat</b>	<b>2000 106342</b>
<b>VENX3 12HP</b>	<b>Parlak</b>	<b>2000 106343</b>

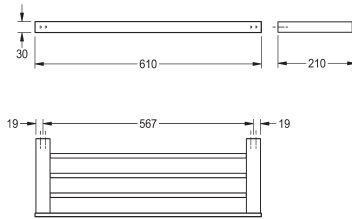

Duvar bağlantılı çoklu havlu rafı ve askı kombinasyonu  
304 kalite paslanmaz çelik  
Sabitlemek için alttan delinmiş yuvarlak bağlantı noktaları SS vida ve tespit pimlerini içerir  
610x210x30 mm

## Cubus

<b>CUBX0 12</b>	<b>Mat</b>	<b>2000 106360</b>
<b>CUBX0 12HP</b>	<b>Parlak</b>	<b>2000 106361</b>

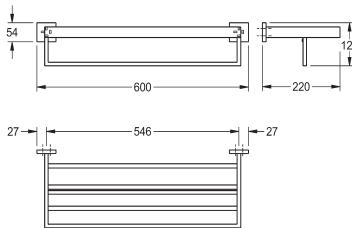

Duvar bağlantılı çoklu havlu rafı ve askı kombinasyonu  
304 kalite paslanmaz çelik  
Sabitlemek için alttan delinmiş yuvarlak bağlantı noktaları SS vida ve tespit pimlerini içerir  
600x220x122 mm

## Havlu Kolu

<b>Medius</b>	<b>MEDX004</b>	<b>Mat</b>	<b>2000106246</b>
	<b>MEDX004HP</b>	<b>Parlak</b>	<b>2000106247</b>

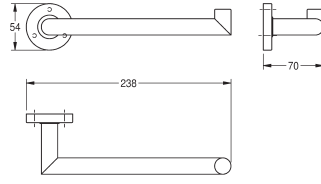

Duvara monte havlu kolu  
304 kalite paslanmaz çelik  
Sabitlemek için alttan delinmiş yuvarlak bağlantı noktaları SS vida ve tespit pimlerini içerir  
238x70x54 mm

<b>Firmus</b>	<b>FIRX004</b>	<b>Mat</b>	<b>2000106270</b>
	<b>FIRX004HP</b>	<b>Parlak</b>	<b>2000106271</b>

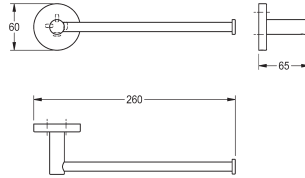

Duvara monte havlu kolu  
304 kalite paslanmaz çelik  
Sabitlemek için alttan delinmiş yuvarlak bağlantı noktaları SS vida ve tespit pimlerini içerir  
260x65x60 mm

<b>Venus</b>	<b>VENX004</b>	<b>Mat</b>	<b>2000106328</b>
	<b>VENX004HP</b>	<b>Parlak</b>	<b>2000106329</b>

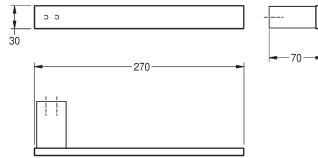

Duvara monte havlu kolu  
304 kalite paslanmaz çelik  
Sabitlemek için alttan delinmiş yuvarlak bağlantı noktaları SS vida ve tespit pimlerini içerir  
270x70x30 mm

<b>Cubus</b>	<b>CUBX004</b>	<b>Mat</b>	<b>2000106350</b>
	<b>CUBX004HP</b>	<b>Parlak</b>	<b>2000106351</b>

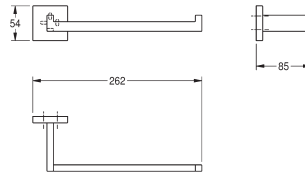

Duvara monte havlu kolu  
304 kalite paslanmaz çelik  
Sabitlemek için alttan delinmiş yuvarlak bağlantı noktaları SS vida ve tespit pimlerini içerir  
262x85x54 mm

## Halka Havluluk

<b>Medius</b>	<b>MEDX104</b>	<b>Mat</b>	<b>2000106384</b>
	<b>MEDX104HP</b>	<b>Parlak</b>	<b>2000106385</b>

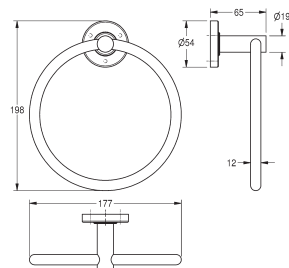

Duvara monte halka havluluk  
304 kalite paslanmaz çelik  
Sabitlemek için alttan delinmiş yuvarlak bağlantı noktaları SS vida ve tespit pimlerini içerir  
177x65x198 mm

<b>Firmus</b>	<b>FIRX104</b>	<b>Mat</b>	<b>2000106282</b>
	<b>FIRX104HP</b>	<b>Parlak</b>	<b>2000106283</b>

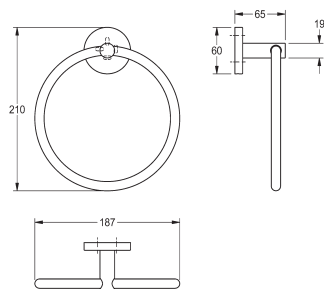

Duvara monte halka havluluk  
304 kalite paslanmaz çelik  
Sabitlemek için alttan delinmiş yuvarlak bağlantı noktaları SS vida ve tespit pimlerini içerir  
187x65x210 mm

## Medius

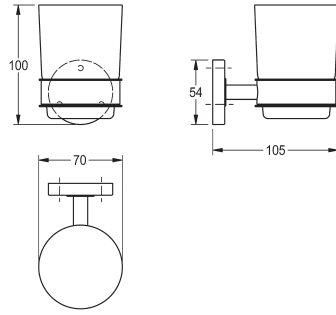

<b>MEDX006</b>	<b>Mat</b>	<b>2000 106250</b>
<b>MEDX006HP</b>	<b>Parlak</b>	<b>2000 106251</b>

Duvara monte diş fırçalık  
304 kalite paslanmaz çelik  
Cam kap  
Sabitlemek için alttan delinmiş yuvarlak bağlantı noktaları  
SS vida ve tespit pimlerini içerir  
70x105x100 mm

## Firmus

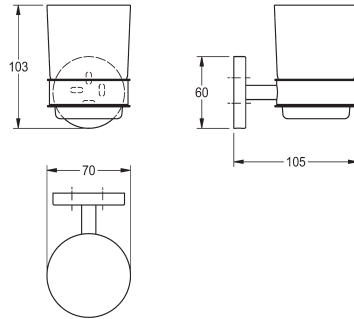

<b>FIRX006</b>	<b>Mat</b>	<b>2000 106274</b>
<b>FIRX006HP</b>	<b>Parlak</b>	<b>2000 106275</b>

Duvara monte diş fırçalık  
304 kalite paslanmaz çelik  
Cam kap  
Sabitlemek için alttan delinmiş yuvarlak bağlantı noktaları  
SS vida ve tespit pimlerini içerir  
70x105x103 mm

## Venus

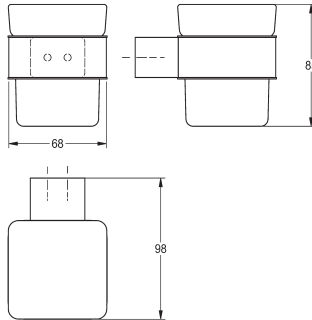

<b>VENX006</b>	<b>Mat</b>	<b>2000 106332</b>
<b>VENX006HP</b>	<b>Parlak</b>	<b>2000 106333</b>

Duvara monte diş fırçalık  
304 kalite paslanmaz çelik  
Cam kap  
Sabitlemek için alttan delinmiş yuvarlak bağlantı noktaları  
SS vida ve tespit pimlerini içerir  
68x98x85 mm

## Cubus

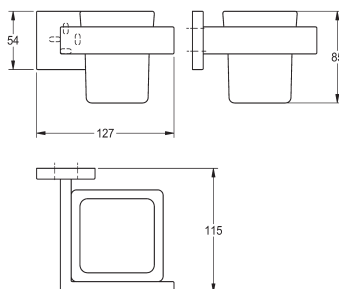

<b>CUBX006</b>	<b>Mat</b>	<b>2000 106354</b>
<b>CUBX006HP</b>	<b>Parlak</b>	<b>2000 106355</b>

Duvara monte diş fırçalık  
304 kalite paslanmaz çelik  
Cam kap  
Sabitlemek için alttan delinmiş yuvarlak bağlantı noktaları  
SS vida ve tespit pimlerini içerir  
127x115x85 mm

## Medius

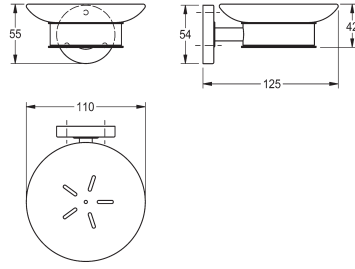

<b>MEDX007</b>	<b>Mat</b>	<b>2000106252</b>
<b>MEDX007HP</b>	<b>Parlak</b>	<b>2000106253</b>

Duvara monte sabunluk rafı  
304 kalite paslanmaz çelik  
Cam kap  
Sabitlemek için alttan delinmiş yuvarlak bağlantı noktaları  
SS vida ve tespit pimlerini içerir  
110x125x55 mm

## Firmus

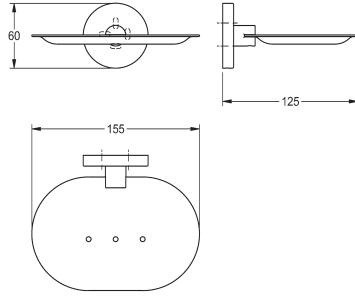

<b>FIRX107</b>	<b>Mat</b>	<b>2000106284</b>
<b>FIRX107HP</b>	<b>Parlak</b>	<b>2000106285</b>

Duvara monte sabunluk rafı  
304 kalite paslanmaz çelik  
Sabitlemek için alttan delinmiş yuvarlak bağlantı noktaları  
SS vida ve tespit pimlerini içerir  
155x125x60 mm

## Venus

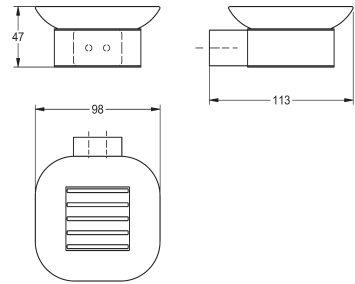

<b>VENX007</b>	<b>Mat</b>	<b>2000106334</b>
<b>VENX007HP</b>	<b>Parlak</b>	<b>2000106335</b>

Duvara monte sabunluk rafı  
304 kalite paslanmaz çelik  
Cam kap  
Sabitlemek için alttan delinmiş yuvarlak bağlantı noktaları  
SS vida ve tespit pimlerini içerir  
98x113x47 mm

## Cubus

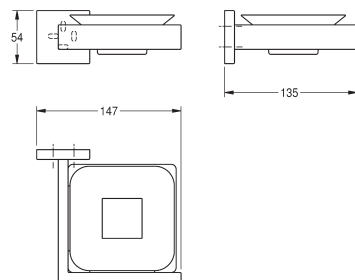

<b>CUBX007</b>	<b>Mat</b>	<b>2000106356</b>
<b>CUBX007HP</b>	<b>Parlak</b>	<b>2000106357</b>

Duvara monte sabunluk rafı  
304 kalite paslanmaz çelik  
Cam kap  
Sabitlemek için alttan delinmiş yuvarlak bağlantı noktaları  
SS vida ve tespit pimlerini içerir  
147x135x54 mm

## Medius

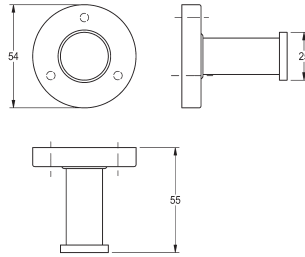

<b>MEDX010</b>	<b>Mat</b>	<b>2000106254</b>
<b>MEDX010HP</b>	<b>Parlak</b>	<b>2000106255</b>

Duvara monte tekli askı  
304 kalite paslanmaz çelik  
Sabitlemek için alttan delinmiş yuvarlak bağlantı noktaları SS vida ve tespit pimlerini içerir  
54x55x54 mm

## Firmus &amp; Icarus

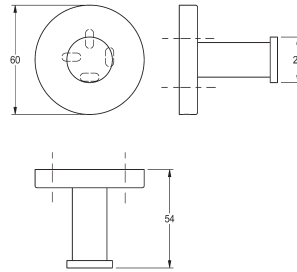

<b>FIRX010</b>	<b>Mat</b>	<b>2000106278</b>
<b>FIRX010HP</b>	<b>Parlak</b>	<b>2000106279</b>

Duvara monte tekli askı  
304 kalite paslanmaz çelik  
Sabitlemek için alttan delinmiş yuvarlak bağlantı noktaları SS vida ve tespit pimlerini içerir  
60x54x60 mm

## Venus

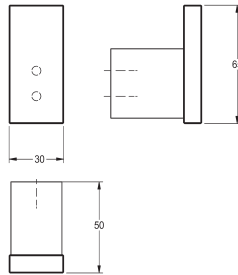

<b>VENX010</b>	<b>Mat</b>	<b>2000106336</b>
<b>VENX010HP</b>	<b>Parlak</b>	<b>2000106337</b>

Duvara monte tekli askı  
304 kalite paslanmaz çelik  
Sabitlemek için alttan delinmiş yuvarlak bağlantı noktaları SS vida ve tespit pimlerini içerir  
30x50x65 mm

## Cubus

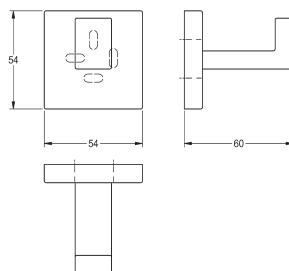

<b>CUBX010</b>	<b>Mat</b>	<b>2000106358</b>
<b>CUBX010HP</b>	<b>Parlak</b>	<b>2000106359</b>

Duvara monte tekli askı  
304 kalite paslanmaz çelik  
Sabitlemek için alttan delinmiş yuvarlak bağlantı noktaları SS vida ve tespit pimlerini içerir  
54x60x54 mm

## Çift Askı / Çöp Kovası / Sabunluk

### Medius

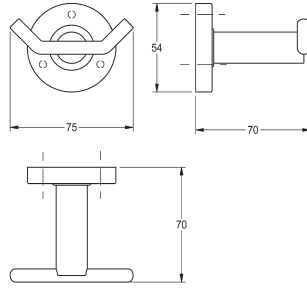

<b>MEDX0110</b>	<b>Mat</b>	<b>2000106260</b>
<b>MEDX0110HP</b>	<b>Parlak</b>	<b>2000106261</b>

Duvara monte çift askı  
304 kalite paslanmaz çelik  
Sabitlemek için alttan delinmiş yuvarlak bağlantı noktaları SS vida ve tespit pimlerini içerir  
75x70x54 mm

### Firmus & Icarus

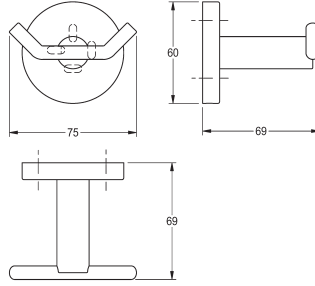
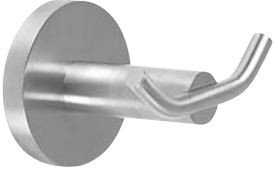

<b>FIRX0110</b>	<b>Mat</b>	<b>2000106286</b>
<b>FIRX0110HP</b>	<b>Parlak</b>	<b>2000106287</b>

Duvara monte çift askı  
304 kalite paslanmaz çelik  
Sabitlemek için alttan delinmiş yuvarlak bağlantı noktaları SS vida ve tespit pimlerini içerir  
75x69x60 mm

### Pedallı çöp kovası

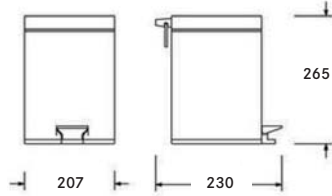

<b>FRKTRD003HP</b>	<b>2030033151</b>
--------------------	-------------------

Pedallı çöp kovası  
304 kalite paslanmaz çelik  
6 litre kapasiteli  
207x265x230 mm

### Köşe Sabunluk

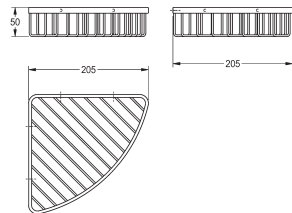

<b>MISX2009</b>	<b>Mat</b>	<b>2000106194</b>
<b>MISX2009HP</b>	<b>Parlak</b>	<b>2000106380</b>

Banyo veya duş için kullanılabilen duvara monte köşe sabunluk  
304 kalite paslanmaz çelik  
SS vida ve tespit pimlerini içerir  
205x205x50 mm

## Medius

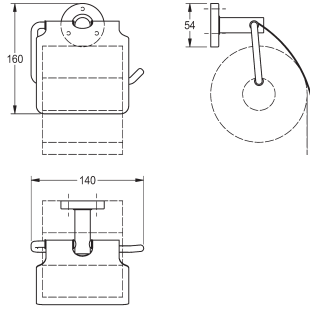

<b>MEDX111</b>	<b>Mat</b>	<b>2000106262</b>
<b>MEDX111HP</b>	<b>Parlak</b>	<b>2000106263</b>

Duvara monte tuvalet kağıtlık  
304 kalite paslanmaz çelik  
ø130 mm çapında max. 1 rulo ile kullanılabilir.  
Paslanmaz çelik katlanabilir kapak  
Sabitlemek için alttan delinmiş yuvarlak bağlantı noktaları SS vida ve tespit pimlerini içerir  
140x65x160 mm

## Firmus

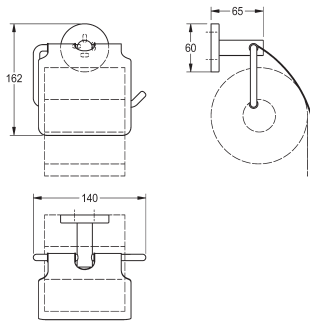

<b>FIRX111</b>	<b>Mat</b>	<b>2000106288</b>
<b>FIRX111HP</b>	<b>Parlak</b>	<b>2000106289</b>

Duvara monte tuvalet kağıtlık  
304 kalite paslanmaz çelik  
ø130 mm çapında max. 1 rulo ile kullanılabilir.  
Paslanmaz çelik katlanabilir kapak  
Sabitlemek için alttan delinmiş yuvarlak bağlantı noktaları SS vida ve tespit pimlerini içerir  
140x65x162 mm

## Venus & Cubus

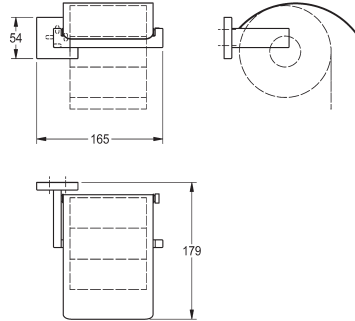

<b>CUBX111</b>	<b>Mat</b>	<b>2000106362</b>
<b>CUBX111HP</b>	<b>Parlak</b>	<b>2000106363</b>

Duvara monte tuvalet kağıtlık  
304 kalite paslanmaz çelik  
ø130 mm çapında max. 1 rulo ile kullanılabilir.  
Paslanmaz çelik katlanabilir kapak  
Sabitlemek için alttan delinmiş yuvarlak bağlantı noktaları SS vida ve tespit pimlerini içerir  
165x179x54 mm

## Tuvalet Fırçalığı

### Medius

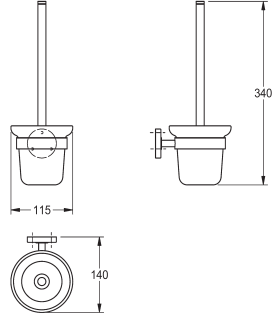

<b>MEDX005</b>	<b>Mat</b>	<b>2000106248</b>
<b>MEDX005HP</b>	<b>Parlak</b>	<b>2000106249</b>

Duvara monte tuvalet fırçalık  
304 kalite paslanmaz çelik saplı fırça  
Cam kap  
Sabitlemek için alttan delinmiş yuvarlak bağlantı noktaları SS vida ve tespit pimlerini içerir  
115x140x340 mm

### Firmus & Icarus

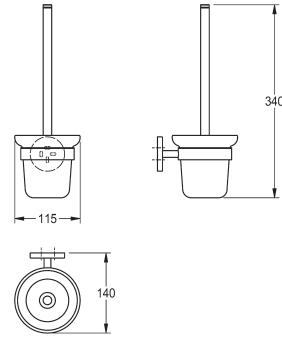

<b>FIRX005</b>	<b>Mat</b>	<b>2000106272</b>
<b>FIRX005HP</b>	<b>Parlak</b>	<b>2000106273</b>

Duvara monte tuvalet fırçalık  
304 kalite paslanmaz çelik saplı fırça  
Cam kap  
Sabitlemek için alttan delinmiş yuvarlak bağlantı noktaları SS vida ve tespit pimlerini içerir  
115x140x340 mm

### Venus

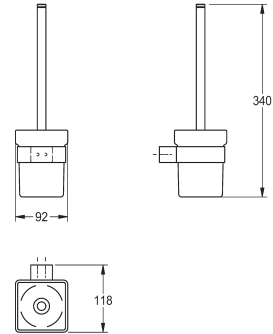

<b>VENX005</b>	<b>Mat</b>	<b>2000106330</b>
<b>VENX005HP</b>	<b>Parlak</b>	<b>2000106331</b>

Duvara monte tuvalet fırçalık  
304 kalite paslanmaz çelik saplı fırça  
Cam kap  
Sabitlemek için alttan delinmiş yuvarlak bağlantı noktaları SS vida ve tespit pimlerini içerir  
92x118x340 mm

### Cubus

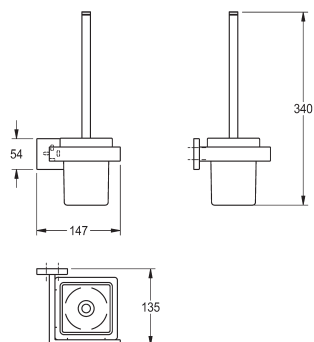

<b>CUBX005</b>	<b>Mat</b>	<b>2000106352</b>
<b>CUBX005HP</b>	<b>Parlak</b>	<b>2000106353</b>

Duvara monte tuvalet fırçalık  
304 kalite paslanmaz çelik saplı fırça  
Cam kap  
Sabitlemek için alttan delinmiş yuvarlak bağlantı noktaları SS vida ve tespit pimlerini içerir  
147x135x340 mm



# OCAKLAR



Make  
it  
Wonderful



# FRANKE OCAĞINI SEÇ

Paslanmaz çelik, cam yada klasik mutfaklar için doğal renklerde tasarlanan Franke imzalı ankastre ocaklar işlevsellik ve estetik arayışın kusursuz bir sentezidir.

## ■ Yüksek etkinliğe sahip yeni Flat Yakıcılar

Çekici bir estetikle birleşen Flat Yakıcılar doğrudan tencere üzerine yönlendirilmiş dikey alevler sayesinde çok yüksek etkinlikte performans ve belirgin enerji tasarrufunu garanti eder.



## ■ Sliding Touch Kontrol



Yenilikçi sistemler sayesinde, induksiyonlu ocak ile etkileşim hızlı ve sezgilere dayalı hale gelerek kaydırmalı kumanda paneli sayesinde kullanımı belirgin ve hassas şekilde farklılaştırır.

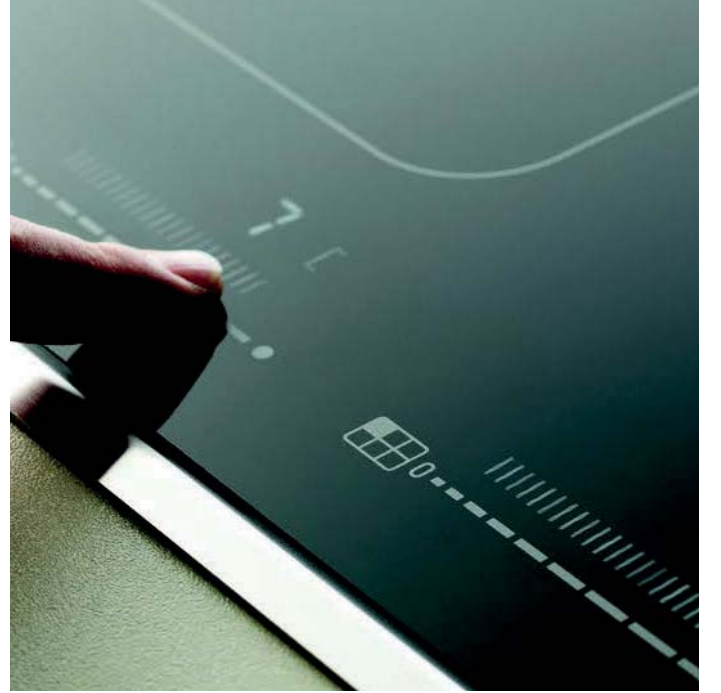

## ■ Opsiyonel düğme kiti



Ocağınızı kendi zevkinize göre yeniden tasarlamaya imkan veren opsiyonel düğme kitleri ocak modeline göre uygun düğmeyi opsiyonel olarak seçmeyi sağlar.



## ■ Profesyonel döküm ızgaralar



Dayanıklılık ve sağlamlık garantisi için dökme demir ızgaralar ideal çözümler sunar. Pişirme alanınıza estetik ve profesyonel bir görüntü sağlar.





### ■ Çift taç

Güçlü alev iki taç üzerine dağılarak eşit ve hızlı bir pişirmeyi garanti eder.



### ■ Üçlü taç

Üçlü taç ocağa yüksek profesyonellik kazandırır. Hızlı ve güçlü pişirme işlemlerini destekler. Üç alev halkası aynı anda yanarak ısıyı çok daha güçlü ve eşit dağıtır.



### ■ Dual power üçlü taç



Alevi maksimum güçte veya daha küçük taçta kullanmaya izin veren son derece esnek ocak gözüdür. Küçük ve büyük çember ayrı ayrı kontrol edilebilir.

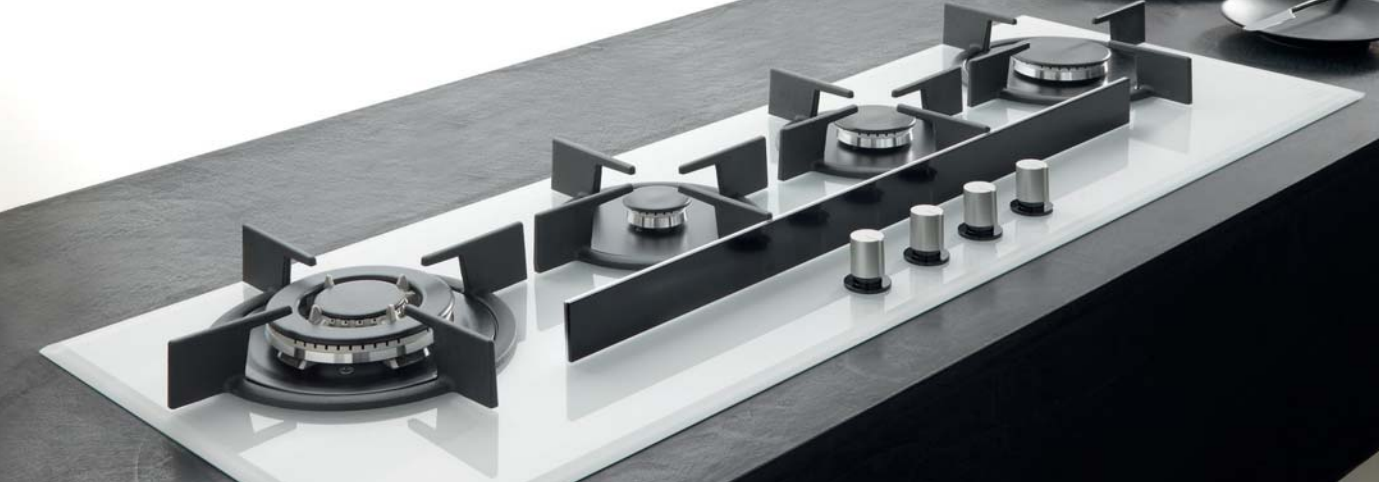

### ■ Malzeme ve renk

Paslanmaz çelik ocaklarda inox, dekor, mikrodekor alternatifi, cam ocaklarda siyah, beyaz renk alternatifi ve klasik ocaklarda avena, grafit, krem, bronz gibi renkleri ile Franke ocaklar modernden klasiğe geniş bir renk ve model yelpazesi sunar.

### ■ Emniyet ventili



Franke için, emniyet elektrikli ev aletlerinde önemli bir şarttır. Bu ventil sayesinde özel bir sistem, alevin kontrol dışı sönmesi halinde gazı keserek güvenliği sağlar.



### ■ Entegre otomatik ateşleme



Ocak gözü içine entegre bir buji sayesinde, başka bir alet kullanmadan ateşin yakılmasına izin verir.



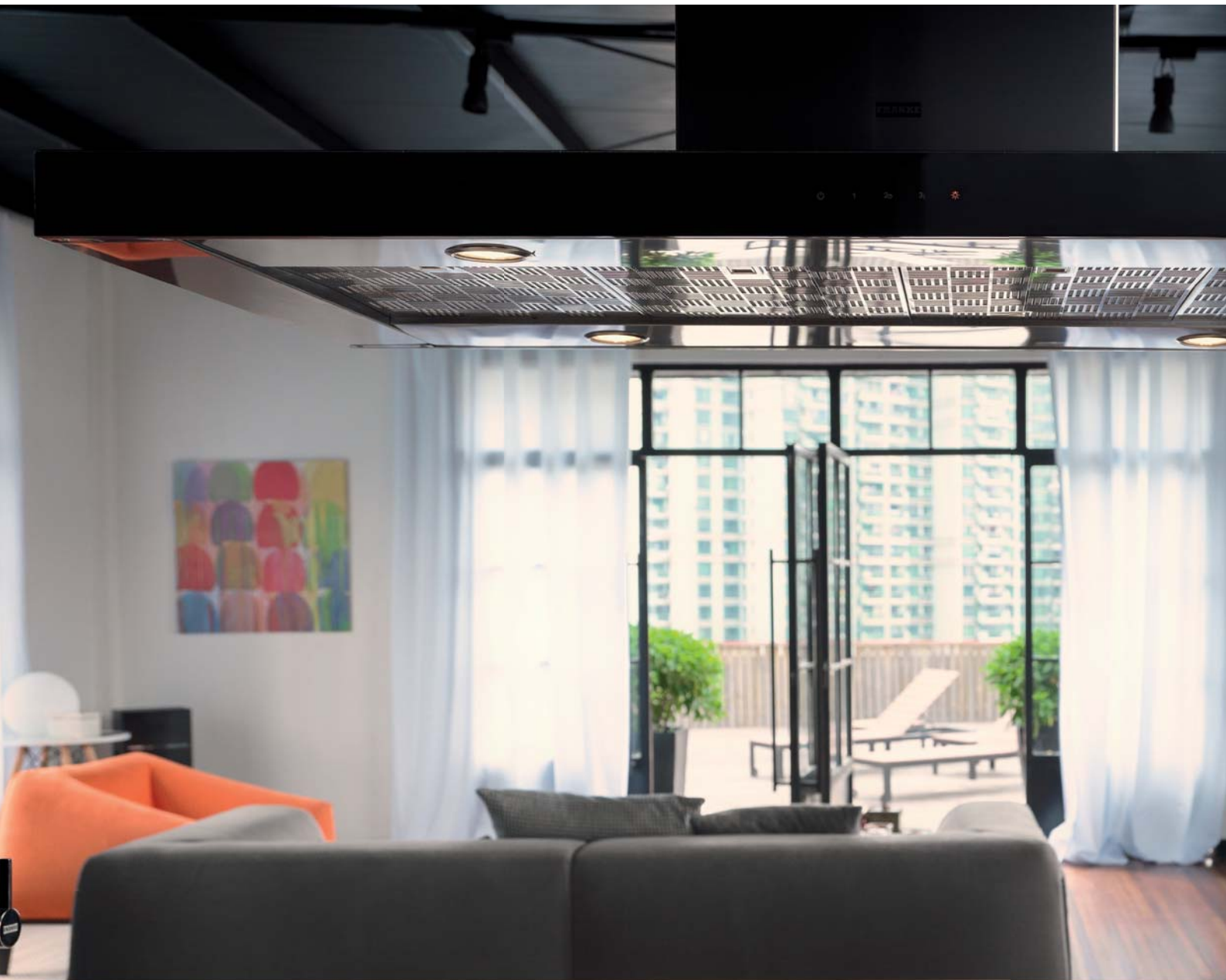



# OCAKLAR

## ÇELİK OCAKLAR

NEW LINEAR	142
TRENDLINE	143
NEPTUN	144
NEPTUN KÖŞE	145
VENÜS / MULTI COOKING 900 / OPERA	146
MULTI COOKING 300	147

## CAM OCAKLAR

NEW SQUARE	148
NEW GLASS LINEAR	149
CRYSTAL STEEL	150-151
CRYSTAL LINE BLACK	152-153
CRYSTAL LINE WHITE	154-155

## ELEKTRİKLİ OCAKLAR

ELEKTRİKLİ CAM SERAMİK	156
GAZ+CAM SERAMİK	157
İNDÜKSİYONLU OCAKLAR	158-163

## KLASİK OCAKLAR

TRENDLINE	164-165
CLASSICLINE	166-167





YENİ

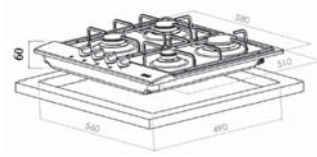

FHNL 604 4G X E

Inox



106.0489.620

Montaj tipi  
Göz sayısı  
Ebat  
Montaj ölçüsü  
Izgaralar  
Gaz giriş yönü  
Özellik  
Alt Dolap ölçüsü

Tezgah Üstü  
4 (gazlı)  
580x510 mm  
560x490 mm  
Emaye  
Sağ  
Gaz emniyet ventili, elektronik ateşleme  
Minimum 60 cm  
New Glass Linear fırınlarla uyumlu  
düğme tasarımı



YENİ

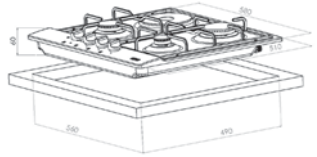

FHNL 604 3G 1E XS E

Inox



107.0489.671

Montaj tipi  
Göz sayısı  
Ebat  
Montaj ölçüsü  
Izgaralar  
Gaz giriş yönü  
Özellik  
Alt Dolap ölçüsü

Tezgah Üstü  
4 (3 gaz/1 elektrik)  
580x510 mm  
560x490 mm  
Emaye  
Sağ  
Gaz emniyet ventili, elektronik ateşleme  
Minimum 60 cm  
New Glass Linear fırınlarla uyumlu  
düğme tasarımı



YENİ

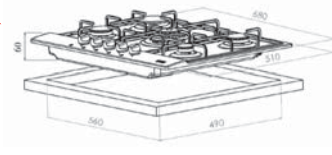

FHNL 705 4G TC XS E

Inox



106.0489.672

Montaj tipi  
Göz sayısı  
Ebat  
Montaj ölçüsü  
Izgaralar  
Gaz giriş yönü  
Özellik  
Alt Dolap ölçüsü

Tezgah Üstü  
5 (5 gaz / 1 gözü 3 taçlı wok gözü)  
680x510 mm  
560x490 mm  
Emaye  
Sağ  
Gaz emniyet ventili, elektronik ateşleme  
Minimum 60 cm  
New Glass Linear fırınlarla uyumlu  
düğme tasarımı

Wok tava aparatı

112.0494.293

opsiyoneldir



YENİ

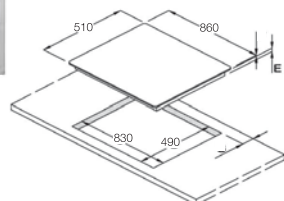

FHNL 905 4G TC XS C

Inox



106.0489.673

Montaj tipi  
Göz sayısı  
Ebat  
Montaj ölçüsü  
Izgaralar  
Gaz giriş yönü  
Özellik  
Alt Dolap ölçüsü

Tezgah Üstü  
5 (5 gaz / 1 gözü 3 taçlı wok gözü)  
860 x 510 mm  
830 x 490 mm  
Döküm ızgara  
Sağ  
Gaz emniyet ventili, elektronik ateşleme  
Minimum 90 cm  
New Glass Linear fırınlarla uyumlu  
düğme tasarımı

Wok tava aparatı

112.0494.293

opsiyoneldir



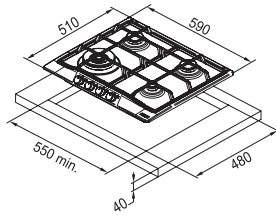

FHTL 604 3G TC XS C  
FHTL 604 3G TC XT C

Inox  
M.dekor



106.0183.016  
106.0183.071

Montaj tipi  
Göz sayısı  
Ebat  
Montaj ölçüsü  
Izgaralar  
Gaz giriş yönü  
Özellik  
Alt Dolap ölçüsü

Tezgah Üstü  
4 (4 gaz / 1 gözü 3 taçlı wok gözü)  
590x510 mm  
550x480 mm  
Döküm ızgara  
Sağ  
Gaz emniyet ventili, elektronik ateşleme  
Minimum 60 cm

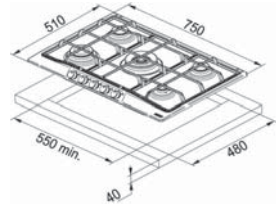

FHTL 755 4G TC XS C  
FHTL 755 4G TC XT C

Inox  
M.dekor



106.0183.104  
106.0183.105

Montaj tipi  
Göz sayısı  
Ebat  
Montaj ölçüsü  
Izgaralar  
Gaz giriş yönü  
Özellik  
Alt Dolap ölçüsü

Tezgah Üstü  
5 (5 gaz / 1 gözü 3 taçlı wok gözü)  
750x510 mm  
550x480 mm  
Döküm ızgara  
Sağ  
Gaz emniyet ventili, elektronik ateşleme  
Minimum 60 cm



### Mat krom düğme

112.0188.696  
(4 ad.)

112.0188.693  
(5 ad.)



Trendline modelleri ile uyumludur.  
opsiyoneldir

### Mat bronz düğme

112.0188.698  
(4 ad.)

112.0188.697  
(5 ad.)



Trendline modelleri ile uyumludur.  
opsiyoneldir





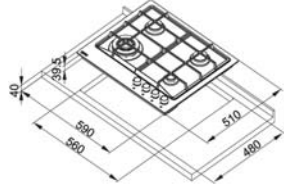

FHNE 604 3G TC XS C

Inox

106.0155.167

Montaj tipi

Göz sayısı

Ebat

Montaj ölçüsü

Izgaralar

Gaz giriş yönü

Özellik

Alt Dolap ölçüsü

Tezgah Üstü

4 (4 gaz/1 gözü 3 taçlı wok)

590x510 mm

560x480 mm

Döküm ızgara

Sol

Gaz emniyet ventili, elektronik ateşleme

Minimum 60 cm

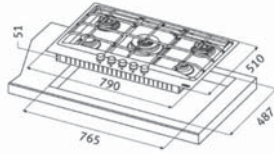

FHNE 805 4G TC XS C

Inox

106.0049.039

Montaj tipi

Göz sayısı

Ebat

Montaj ölçüsü

Izgaralar

Gaz giriş yönü

Özellik

Alt Dolap ölçüsü

Tezgah Üstü

5 (5 gaz/1 gözü 3 taçlı wok/

2 ad. çift taçlı eko wok)

790x510 mm

765x487 mm

Döküm ızgara

Sağ

Gaz emniyet ventili, elektronik ateşleme

Minimum 80 cm

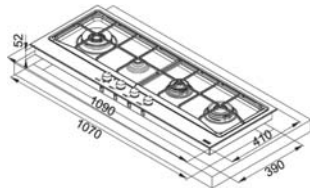

FHNE 1204 3G TC XS C

Inox

106.0064.312

Montaj tipi

Göz sayısı

Ebat

Montaj ölçüsü

Izgaralar

Gaz giriş yönü

Özellik

Alt Dolap ölçüsü

Tezgah Üstü

4 (4 gaz/1 gözü dual/2 ad. çift taçlı eko wok)

1090x410 mm

1070x390 mm

Döküm ızgara

Sağ

Gaz emniyet ventili, elektronik ateşleme Dual

power özelliği

Minimum 120 cm

## Neptun Tezgaha "0"

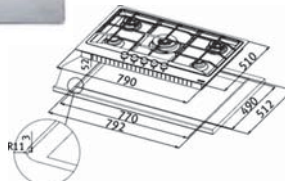

FHNE 805 4G TC XS C FM

Inox

106.0055.776

Montaj tipi

Göz sayısı

Ebat

Montaj ölçüsü

Izgaralar

Gaz giriş yönü

Özellik

Alt Dolap ölçüsü

Tezgaha sıfır

5 (5 gaz/1 gözü 3 taçlı wok/

2 ad. çift taçlı eko wok)

790x510 mm

770-792x490-512 mm

Döküm ızgara

Sağ

Gaz emniyet ventili, elektronik ateşleme

Minimum 80 cm



FHNE COR 4 3G TC XS C

Inox



106.0204.367

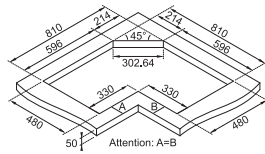

Montaj tipi

Göz sayısı

Ebat

Montaj ölçüsü

Izgaralar

Gaz giriş yönü

Özellik

Alt Dolap ölçüsü

Tezgah Üstü

4 (4 gaz/1 gözü dual/1 gözü 3 taçlı wok)

830x830x500 mm

Kutuların içinde şablon mevcuttur.

Döküm izgara

Sağ

Gaz emniyet ventili, elektronik ateşleme,

Dual Power özelliği

90° Köşe



## Dual Power Ocak



Ocak özelliklerine ait sembollerinin açıklamalarını öğrenmek için arka kapak içindeki tabloyu inceleyebilirsiniz.

# VENUS / MULTI COOKING 900 / OPERA

## Venüs

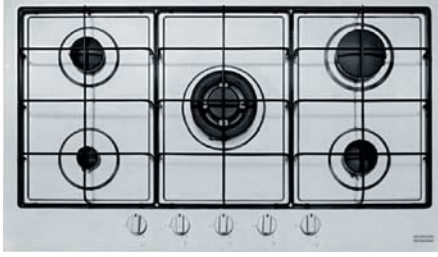

FHX 905 4G TC XS E

Inox



106.0284.621

Montaj tipi  
Göz sayısı  
Ebat  
Montaj ölçüsü  
Izgaralar  
Gaz giriş yönü  
Özellik  
Alt Dolap ölçüsü

Tezgah Üstü  
5 (5 gaz / 1 gözü 3 taçlı wok)  
880x510 mm  
860x490 mm  
Emaye (Döküm izgara opsiyoneldir)  
Sağ  
Gaz emniyet ventili, elektronik ateşleme  
Minimum 90 cm

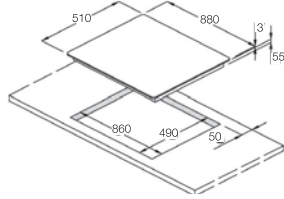

Döküm izgara

112.0362.930



opsiyoneldir



## Multi Cooking 900



FHM 905 4G LTC XS C

Inox



106.0180.937

Montaj tipi  
Göz sayısı  
Ebat  
Montaj ölçüsü  
Izgaralar  
Gaz giriş yönü  
Özellik  
Alt Dolap ölçüsü

Tezgah Üstü  
5 (5 gaz / 1 gözü 3 taçlı wok)  
880x510 mm  
840x480 mm  
Döküm izgara  
Sağ  
Gaz emniyet ventili, elektronik ateşleme  
Minimum 90 cm

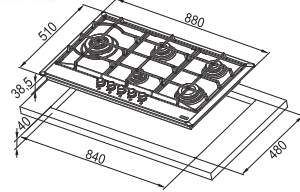

## Opera



POI 6 3GAV-D-O  
POL 6 3GAV-D-O

Inox



106.0017.384

Dekor



106.0017.383

Montaj tipi  
Göz sayısı  
Ebat  
Montaj ölçüsü  
Izgaralar  
Gaz giriş yönü  
Özellik

Tezgah Üstü  
5 (5 gaz / 1 gözü dual/1 özel balık gözü)  
890x500 mm  
840x480 mm  
Döküm izgara  
Sol  
Gaz emniyet ventili, elektronik ateşleme,  
Dual Power özelliği ve iç, dış halkalar için  
2 ayrı kumanda düğmesi  
Minimum 90 cm

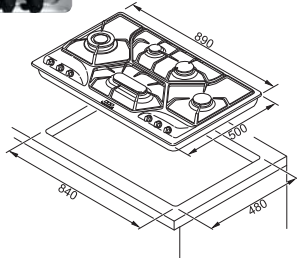

Alt Dolap ölçüsü

Mat krom düğme

112.0027.750  
(6 ad.)



opsiyoneldir

## Dual Power Ocak



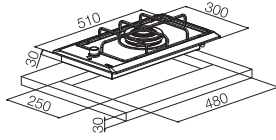

**FHM 301 1TC XS C**

**Inox**

**106.0026.890**

Montaj tipi  
Göz sayısı  
Ebat  
Montaj ölçüsü  
Izgaralar  
Gaz giriş yönü  
Özellik  
Alt Dolap ölçüsü

Tezgah üstü  
1 (3 taçlı wok)  
300x510 mm  
250x480 mm  
Döküm ızgara  
Sağ  
Gaz emniyet ventili, elektronik ateşleme  
Minimum 30 cm

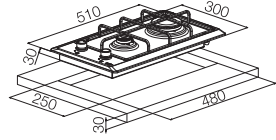

**FHM 302 2G XS C**

**Inox**

**106.0037.498**

Montaj tipi  
Göz sayısı  
Ebat  
Montaj ölçüsü  
Izgaralar  
Gaz giriş yönü  
Özellik  
Alt Dolap ölçüsü

Tezgah üstü  
2 (Gazlı)  
300x510 mm  
250x480 mm  
Döküm ızgara  
Sağ  
Gaz emniyet ventili, elektronik ateşleme  
Minimum 30 cm

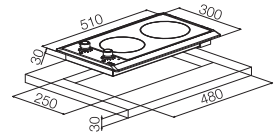

**FHM 302 2C M XS**

**Inox**

**108.0026.893**

Montaj tipi  
Göz sayısı

Tezgah üstü  
2 (Elektrikli cam seramik)  
ø 140 mm 1200 W  
ø 160 mm 1500 W  
300x510 mm  
250x480 mm  
Minimum 30 cm

Ebat  
Montaj ölçüsü  
Alt Dolap ölçüsü

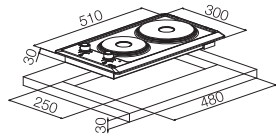

**FHM 302 2E XS**

**Inox**

**108.0037.504**

Montaj tipi  
Göz sayısı

Tezgah üstü  
2 (Elektrikli, ısı korumalı)  
ø 180 mm 2000 W  
ø 145 mm 1000 W  
300x510 mm  
250x480 mm  
Minimum 30 cm

Ebat  
Montaj ölçüsü  
Alt Dolap ölçüsü

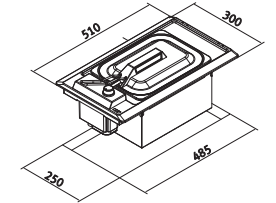

**FHM 301 FR XS**

**Inox**

**108.0047.444**

Montaj tipi  
Güç  
Ebat  
Montaj ölçüsü  
Alt Dolap ölçüsü

Tezgah üstü Fritöz  
2300 W  
300x510x155 mm  
250x485x173,5 mm  
Minimum 30 cm

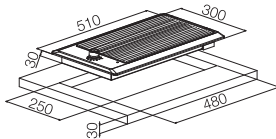

**FHM 301 BQ XS**

**Inox**

**108.0047.443**

Montaj tipi  
Güç  
Ebat  
Montaj ölçüsü  
Alt Dolap ölçüsü

Tezgah üstü Barbekü  
2400 W  
300x510x50 mm  
250x480 mm  
Minimum 30 cm

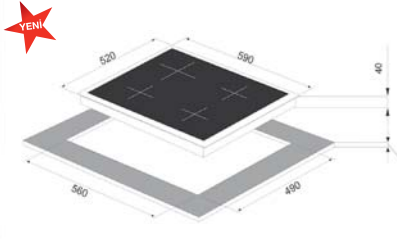

**FHNS 604 4G WH C**

**White Glass**

**106.0489.961**

Montaj tipi  
Göz sayısı  
Ebat  
Montaj ölçüsü  
Izgaralar  
Gaz giriş yönü  
Özellik  
Alt Dolap ölçüsü

Tezgah üstü  
4 (Gazlı)  
590x520 mm  
560x490 mm  
Döküm ızgara  
Sağ  
Gaz emniyet ventili, elektronik ateşleme  
Minimum 60 cm  
**New Glass Linear fırınlarla uyumlu düğme tasarımı**

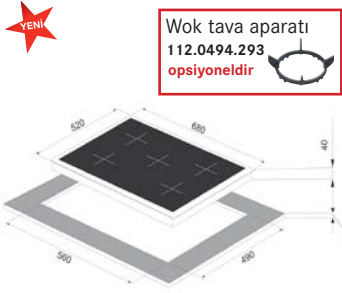

**FHNS 705 4G TC WH C**

**White Glass**

**106.0490.103**

Montaj tipi  
Göz sayısı  
Ebat  
Montaj ölçüsü  
Izgaralar  
Gaz giriş yönü  
Özellik  
Alt Dolap ölçüsü

Tezgah üstü  
5 (5 gaz / 1 gözü 3 taçlı wok)  
680x520 mm  
560x490 mm  
Döküm ızgara  
Sağ  
Gaz emniyet ventili, elektronik ateşleme  
Minimum 60 cm  
**New Glass Linear fırınlarla uyumlu düğme tasarımı**



**FHNS 905 4G TC WH C**

**White Glass**

**106.0490.105**

Montaj tipi  
Göz sayısı  
Ebat  
Montaj ölçüsü  
Izgaralar  
Gaz giriş yönü  
Özellik  
Alt Dolap ölçüsü

Tezgah üstü  
5 (5 gaz / 1 gözü 3 taçlı wok)  
860x520 mm  
830x490 mm  
Döküm ızgara  
Sağ  
Gaz emniyet ventili, elektronik ateşleme  
Minimum 90 cm  
**New Glass Linear fırınlarla uyumlu düğme tasarımı**

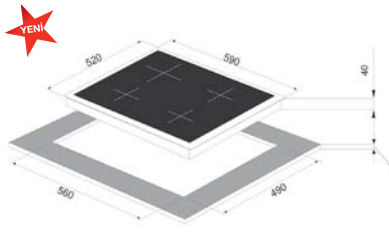

**FHNS 604 4G BK C**

**Black Glass**

**106.0489.940**

Montaj tipi  
Göz sayısı  
Ebat  
Montaj ölçüsü  
Izgaralar  
Gaz giriş yönü  
Özellik  
Alt Dolap ölçüsü

Tezgah üstü  
4 (Gazlı)  
590x520 mm  
560x490 mm  
Döküm ızgara  
Sağ  
Gaz emniyet ventili, elektronik ateşleme  
Minimum 60 cm  
**New Glass Linear fırınlarla uyumlu düğme tasarımı**

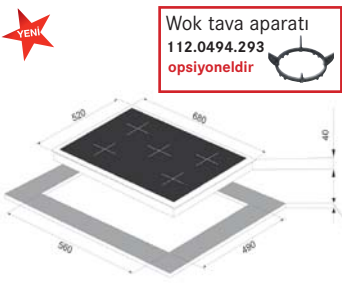

**FHNS 705 4G TC BK C**

**Black Glass**

**106.0490.102**

Montaj tipi  
Göz sayısı  
Ebat  
Montaj ölçüsü  
Izgaralar  
Gaz giriş yönü  
Özellik  
Alt Dolap ölçüsü

Tezgah üstü  
5 (5 gaz / 1 gözü 3 taçlı wok)  
680x520 mm  
560x490 mm  
Döküm ızgara  
Sağ  
Gaz emniyet ventili, elektronik ateşleme  
Minimum 60 cm  
**New Glass Linear fırınlarla uyumlu düğme tasarımı**



**FHNS 905 4G TC BK C**

**Black Glass**

**106.0490.104**

Montaj tipi  
Göz sayısı  
Ebat  
Montaj ölçüsü  
Izgaralar  
Gaz giriş yönü  
Özellik  
Alt Dolap ölçüsü

Tezgah üstü  
5 (5 gaz / 1 gözü 3 taçlı wok)  
860x520 mm  
830x490 mm  
Döküm ızgara  
Sağ  
Gaz emniyet ventili, elektronik ateşleme  
Minimum 90 cm  
**New Glass Linear fırınlarla uyumlu düğme tasarımı**





YENİ

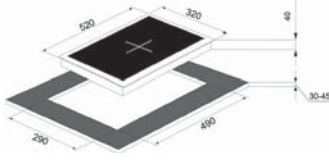

**FHNG 302 2G BK C**

**Black Glass**

**106.0490.202**

Montaj tipi  
Göz sayısı  
Ebat  
Montaj ölçüsü  
Izgaralar  
Gaz giriş yönü  
Özellik  
Alt Dolap ölçüsü

Tezgah üstü  
2 (Gazlı)  
320x520 mm  
290x490 mm  
Döküm izgara  
Sağ  
Gaz emniyet ventili, elektronik ateşleme  
Minimum 30 cm  
**New Glass Linear fırınlarla uyumlu düğme tasarımı**



YENİ

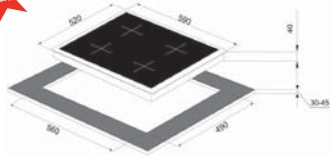

**FHNG 604 4G BK C**

**Black Glass**

**106.0490.176**

Montaj tipi  
Göz sayısı  
Ebat  
Montaj ölçüsü  
Izgaralar  
Gaz giriş yönü  
Özellik  
Alt Dolap ölçüsü

Tezgah üstü  
4 (Gazlı)  
590x520 mm  
560x490 mm  
Döküm izgara  
Sağ  
Gaz emniyet ventili, elektronik ateşleme  
Minimum 60 cm  
**New Glass Linear fırınlarla uyumlu düğme tasarımı**



YENİ

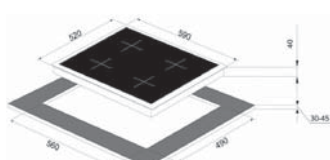

**FHNG 604 4G TC BK C**

**Black Glass**

**106.0490.177**

Montaj tipi  
Göz sayısı  
Ebat  
Montaj ölçüsü  
Izgaralar  
Gaz giriş yönü  
Özellik  
Alt Dolap ölçüsü

Tezgah üstü  
4 (4 gaz / 1 gözü 3 taçlı wok )  
590x520 mm  
560x490 mm  
Döküm izgara  
Sağ  
Gaz emniyet ventili, elektronik ateşleme  
Minimum 60 cm  
**New Glass Linear fırınlarla uyumlu düğme tasarımı**



YENİ

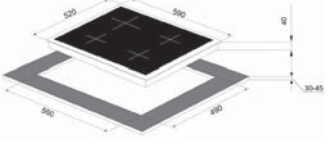

**FHNG 604 3G 1E BK C**

**Black Glass**

**107.0490.178**

Montaj tipi  
Göz sayısı  
Ebat  
Montaj ölçüsü  
Izgaralar  
Gaz giriş yönü  
Özellik  
Alt Dolap ölçüsü

Tezgah üstü  
4 (4 gaz / 1 elektrik)  
590x520 mm  
560x490 mm  
Döküm izgara  
Sağ  
Gaz emniyet ventili, elektronik ateşleme  
Minimum 60 cm  
**New Glass Linear fırınlarla uyumlu düğme tasarımı**



YENİ

Wok tava aparatı  
112.0494.293  
opsiyoneldir

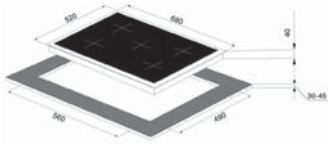

**FHNG 705 4G TC BK C**

**Black Glass**

**106.0490.179**

Montaj tipi  
Göz sayısı  
Ebat  
Montaj ölçüsü  
Izgaralar  
Gaz giriş yönü  
Özellik  
Alt Dolap ölçüsü

Tezgah üstü  
5 (5 gaz / 1 gözü 3 taçlı wok)  
680x520 mm  
560x490 mm  
Döküm izgara  
Sağ  
Gaz emniyet ventili, elektronik ateşleme  
Minimum 60 cm  
**New Glass Linear fırınlarla uyumlu düğme tasarımı**



YENİ

Wok tava aparatı  
112.0494.293  
opsiyoneldir

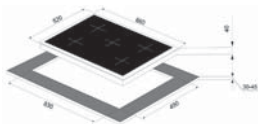

**FHNG 905 4G TC BK C**

**Black Glass**

**106.0490.180**

Montaj tipi  
Göz sayısı  
Ebat  
Montaj ölçüsü  
Izgaralar  
Gaz giriş yönü  
Özellik  
Alt Dolap ölçüsü

Tezgah üstü  
5 (5 gaz / 1 gözü 3 taçlı wok)  
860x520 mm  
830x490 mm  
Döküm izgara  
Sağ  
Gaz emniyet ventili, elektronik ateşleme  
Minimum 90 cm  
**New Glass Linear fırınlarla uyumlu düğme tasarımı**



YENİ



## YÜKSEK ETKİNLİĞE SAHİP YENİ FLAT YAKICILAR

Tüm Crystal Line Steel Serisi ocaklarda çekici bir estetikle birleşen Flat yakıcılar sayesinde doğrudan tencere üzerine yönlendirilmiş dikey alevler yüksek etkinlikte performans ve belirgin enerji tasarrufunu garanti eder.





YENİ

FHCR 604 4G HE XS C

Mirror Steel  
Nero

106.0374.282

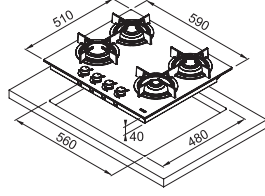

Montaj tipi  
Göz sayısı  
Ebat  
Montaj ölçüsü  
Izgaralar  
Gaz giriş yönü  
Özellik  
Alt Dolap ölçüsü

Tezgah üstü  
4 (Gazlı)  
590x510 mm  
560x480 mm  
Döküm ızgara  
Sağ  
Gaz emniyet ventili, elektronik ateşleme  
Minimum 60 cm



YENİ

FHCR 755 4G TC HE XS C

Mirror Steel  
Nero

106.0374.285

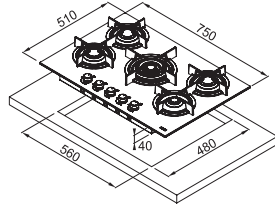

Montaj tipi  
Göz sayısı  
Ebat  
Montaj ölçüsü  
Izgaralar  
Gaz giriş yönü  
Özellik  
Alt Dolap ölçüsü

Tezgah üstü  
5 (5 gaz / 1 gözü 3 taçlı wok)  
750x510 mm  
560x480 mm  
Döküm ızgara  
Sağ  
Gaz emniyet ventili, elektronik ateşleme  
Minimum 60 cm



YENİ

FHCR 905 4G TC HE XS C

Mirror Steel  
Nero

106.0374.291

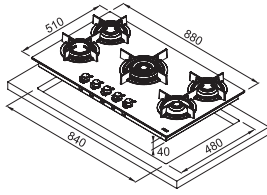

Montaj tipi  
Göz sayısı  
Ebat  
Montaj ölçüsü  
Izgaralar  
Gaz giriş yönü  
Özellik  
Alt Dolap ölçüsü

Tezgah üstü  
5 (5 gaz / 1 gözü 3 taçlı wok)  
880x510 mm  
840x480 mm  
Döküm ızgara  
Sağ  
Gaz emniyet ventili, elektronik ateşleme  
Minimum 90 cm



YENİ

FHCR 1204 3G TC HE XS C

Mirror Steel  
Nero

106.0374.294

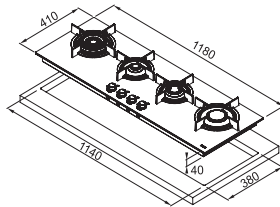

Montaj tipi  
Göz sayısı  
Ebat  
Montaj ölçüsü  
Izgaralar  
Gaz giriş yönü  
Özellik  
Alt Dolap ölçüsü

Tezgah üstü  
4 (4 gaz / 1 gözü 3 taçlı wok)  
1180x410 mm  
1140x380 mm  
Döküm ızgara  
Sağ  
Gaz emniyet ventili, elektronik ateşleme  
Minimum 120 cm



YENİ



## YÜKSEK ETKİNLİĞE SAHİP YENİ FLAT YAKICILAR

Tüm Crystal Line Black Serisi ocaklarda çekici bir estetikle birleşen Flat yakıcılar sayesinde doğrudan tencere üzerine yönlendirilmiş dikey alevler yüksek etkinlikte performans ve belirgin enerji tasarrufunu garanti eder.



YENİ

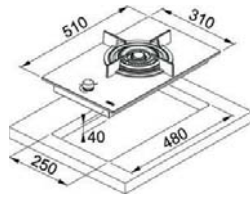

**FHCR 301 1TC HE BK C**

**Cristallo Nero**

**106.0374.275**

Montaj tipi  
Göz sayısı  
Ebat  
Montaj ölçüsü  
Izgaralar  
Gaz giriş yönü  
Özellik  
Alt Dolap ölçüsü

Tezgah üstü  
1 (3 taçlı wok)  
310x510 mm  
250x480 mm  
Döküm ızgara  
Sağ  
Gaz emniyet ventili, elektronik ateşleme  
Minimum 40 cm



YENİ

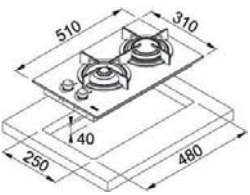

**FHCR 302 2G HE BK C**

**Cristallo Nero**

**106.0374.278**

Montaj tipi  
Göz sayısı  
Ebat  
Montaj ölçüsü  
Izgaralar  
Gaz giriş yönü  
Özellik  
Alt Dolap ölçüsü

Tezgah üstü  
2 (Gazlı)  
310x510 mm  
250x480 mm  
Döküm ızgara  
Sağ  
Gaz emniyet ventili, elektronik ateşleme  
Minimum 40 cm





YENİ

FHCR 604 4G HE BK C

Cristallo  
Nero

106.0374.280

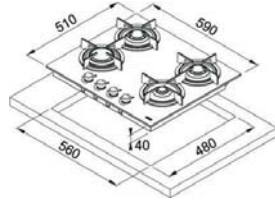

Montaj tipi  
Göz sayısı  
Ebat  
Montaj ölçüsü  
Izgaralar  
Gaz giriş yönü  
Özellik  
Alt Dolap ölçüsü

Tezgah üstü  
4 (Gazlı)  
590x510 mm  
560x480 mm  
Döküm ızgara  
Sağ  
Gaz emniyet ventili, elektronik ateşleme  
Minimum 60 cm

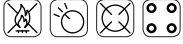

YENİ

FHCR 755 4G TC HE BK C

Cristallo  
Nero

106.0374.283

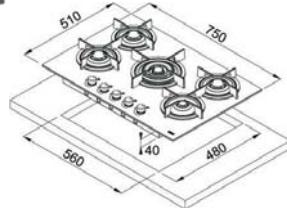

Montaj tipi  
Göz sayısı  
Ebat  
Montaj ölçüsü  
Izgaralar  
Gaz giriş yönü  
Özellik  
Alt Dolap ölçüsü

Tezgah üstü  
5 (5 gaz / 1 gözü 3 taçlı wok)  
750x510 mm  
560x480 mm  
Döküm ızgara  
Sağ  
Gaz emniyet ventili, elektronik ateşleme  
Minimum 60 cm



YENİ

FHCR 905 4G TC HE BK C

Cristallo  
Nero

106.0374.288

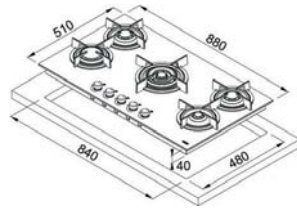

Montaj tipi  
Göz sayısı  
Ebat  
Montaj ölçüsü  
Izgaralar  
Gaz giriş yönü  
Özellik  
Alt Dolap ölçüsü

Tezgah üstü  
5 (5 gaz / 1 gözü 3 taçlı wok)  
880x510 mm  
840x480 mm  
Döküm ızgara  
Sağ  
Gaz emniyet ventili, elektronik ateşleme  
Minimum 90 cm



YENİ

FHCR 1204 3G TC HE BK C

Cristallo  
Nero

106.0374.292

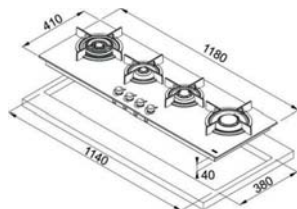

Montaj tipi  
Göz sayısı  
Ebat  
Montaj ölçüsü  
Izgaralar  
Gaz giriş yönü  
Özellik  
Alt Dolap ölçüsü

Tezgah üstü  
4 (4 gaz / 1 gözü 3 taçlı wok)  
1180x410 mm  
1140x380 mm  
Döküm ızgara  
Sağ  
Gaz emniyet ventili, elektronik ateşleme  
Minimum 120 cm





## YÜKSEK ETKİNLİĞE SAHİP YENİ FLAT YAKICILAR

Tüm Crystal Line White Serisi ocaklarda çekici bir estetikle birleşen Flat yakıcılar sayesinde doğrudan tencere üzerine yönlendirilmiş dikey alevler yüksek etkinlikte performans ve belirgin enerji tasarrufunu garanti eder.





YENİ

FHCR 604 4G HE WH C

Cristallo  
Bianco

106.0374.281

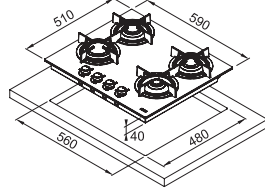

Montaj tipi  
Göz sayısı  
Ebat  
Montaj ölçüsü  
Izgaralar  
Gaz giriş yönü  
Özellik  
Alt Dolap ölçüsü

Tezgah üstü  
4 (Gazlı)  
590x510 mm  
560x480 mm  
Döküm ızgara  
Sağ  
Gaz emniyet ventili, elektronik ateşleme  
Minimum 60 cm



YENİ

FHCR 755 4G TC HE WH C

Cristallo  
Bianco

106.0374.284

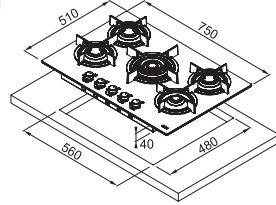

Montaj tipi  
Göz sayısı  
Ebat  
Montaj ölçüsü  
Izgaralar  
Gaz giriş yönü  
Özellik  
Alt Dolap ölçüsü

Tezgah üstü  
5 (5 gaz / 1 gözü 3 taçlı wok)  
750x510 mm  
560x480 mm  
Döküm ızgara  
Sağ  
Gaz emniyet ventili, elektronik ateşleme  
Minimum 60 cm



YENİ

FHCR 905 4G TC HE WH C

Cristallo  
Bianco

106.0374.290

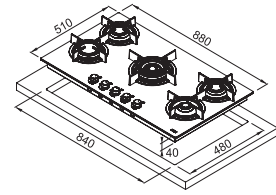

Montaj tipi  
Göz sayısı  
Ebat  
Montaj ölçüsü  
Izgaralar  
Gaz giriş yönü  
Özellik  
Alt Dolap ölçüsü

Tezgah üstü  
5 (5 gaz / 1 gözü 3 taçlı wok)  
880x510 mm  
840x480 mm  
Döküm ızgara  
Sağ  
Gaz emniyet ventili, elektronik ateşleme  
Minimum 90 cm



YENİ

FHCR 1204 3G TC HE WH C

Cristallo  
Bianco

106.0374.293

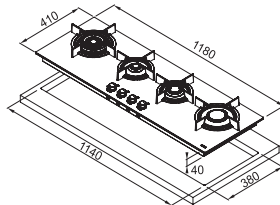

Montaj tipi  
Göz sayısı  
Ebat  
Montaj ölçüsü  
Izgaralar  
Gaz giriş yönü  
Özellik  
Alt Dolap ölçüsü

Tezgah üstü  
4 (4 gaz / 1 gözü 3 taçlı wok)  
1180x410 mm  
1140x380 mm  
Döküm ızgara  
Sağ  
Gaz emniyet ventili, elektronik ateşleme  
Minimum 120 cm



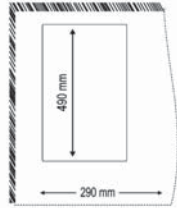

**FHC 2E**

**Black Glass**

**108.0380.405**

**Montaj tipi**  
**Kontrol paneli**  
**Göz sayısı**

Tezgah üstü  
Dokunmatik  
2 (Elektrikli)  
1 x 1200W, 1 x 1800W  
310x520 mm  
290x490x40 mm  
Minimum 30 cm

**Ebat**  
**Montaj ölçüsü**  
**Alt Dolap ölçüsü**

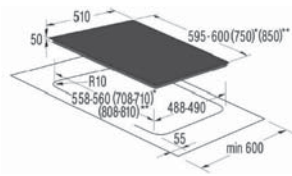

**FHC 6042 BD**

**Black Glass**

**108.0392.231**

**Montaj tipi**  
**Kontrol paneli**  
**Göz sayısı**

Tezgah üstü  
Dokunmatik  
4 (Elektrikli)  
2200w x 1 - 1700w x 1 - 1200w x 2

**Ebat**  
**Montaj ölçüsü**  
**Özellik**

594x510 mm  
560x490x50 mm  
9 ısı kademesi, Her ocak için ışıklı gösterge  
2 gözde 2 çift halka brülörü, timer, çocuk kilidi  
Kullanım sonrası sıcak yüzey göstergesi  
Minimum 60 cm

**Alt Dolap ölçüsü**

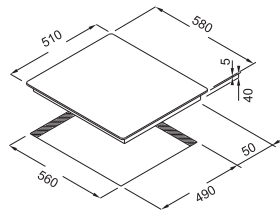
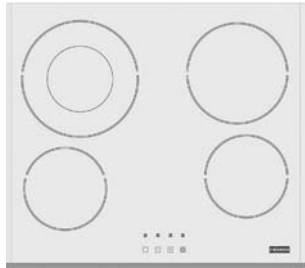

**FHC 604 4C T BP WH**

**White Glass**

**108.0290.071**

**Montaj tipi**  
**Kontrol paneli**  
**Göz sayısı**

Tezgah üstü  
Dokunmatik  
4 (Elektrikli)  
1800Wx1 - 1200Wx2 / 750/2200Wx1

**Ebat**  
**Montaj ölçüsü**  
**Özellik**

580x510 mm  
560x490x40 mm  
9 kademeli ısı ayarı  
Her ocak için ışıklı gösterge, dairesel bir çift halka brülörü, çocuk kilidi  
Minimum 60 cm

**Alt Dolap ölçüsü**

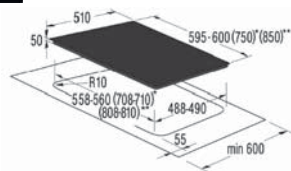

**FHBP 774 BD**

**Black Glass**

**108.0392.236**

**Montaj tipi**  
**Kontrol paneli**  
**Göz sayısı**

Tezgah üstü  
Dokunmatik  
4 (Elektrikli)  
Ön sol göz 2200 W, Arka sol göz 1200 W  
Arka sağ göz 2400 W, Ön sağ göz 1200 W  
770x510 mm

**Ebat**  
**Montaj ölçüsü**  
**Özellik**

710x490x50 mm  
9 kademeli ısı ayarı, otomatik hızlı ön ısıma, dairesel ve oval olmak üzere iki çift halka brülörü  
Minimum 75 cm

**Alt Dolap ölçüsü**

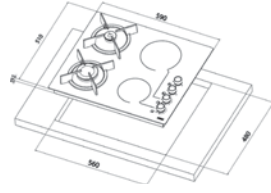
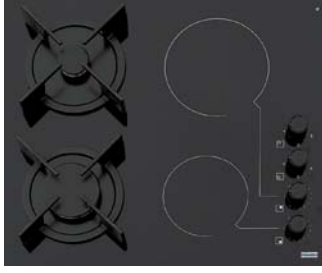

**FHX 604 2G 2C BK C**

**Black Glass**

**107.0059.199**

**Montaj tipi**  
**Kontrol paneli**  
**Göz sayısı**

Tezgah üstü  
Düğmeli  
4 (2 gaz/2 elektrik)

**Ebat**  
**Montaj ölçüsü**  
**Izgaralar**  
**Gaz giriş yönü**  
**Özellik**  
**Alt Dolap ölçüsü**

1200Wx1, 1800Wx1  
590x510 mm  
560x480 mm  
Döküm ızgara  
Sağ  
Gaz emniyet ventili, elektronik ateşleme  
Minimum 60 cm

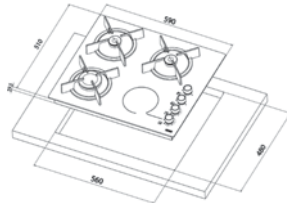
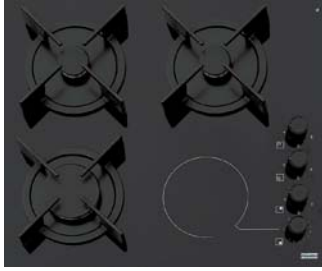

**FHX 604 3G 1C BK C**

**Black Glass**

**107.0152.816**

**Montaj tipi**  
**Kontrol paneli**  
**Göz sayısı**

Tezgah üstü  
Düğmeli  
4 (3 gaz/1 elektrik)

**Ebat**  
**Montaj ölçüsü**  
**Izgaralar**  
**Gaz giriş yönü**  
**Özellik**  
**Alt Dolap ölçüsü**

1200Wx1  
590x510 mm  
560x480 mm  
Döküm ızgara  
Sağ  
Gaz emniyet ventili, elektronik ateşleme  
Minimum 60 cm



## KOLAY TEMİZLİK

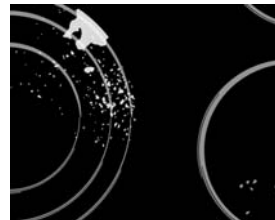

Aşındırıcı olmayan günlük temizleyiciler kullanılmalıdır. Ocak soğukken ve nemli bezlerle günlük temizliği kolayca yapılır.

Yüzeyi sert olmayan bez yada süngerler ile ocak yüzeyindeki kalıntıların temizlenmesi yeterlidir. Ardından kurulanması gerekir.

İnatçı ve kurumuş yemek parçaları ve ocağa yapışan diğer kalıntılar özel kazıma spatulası ile kolaylıkla çıkarılabilir.



# İNDÜKSİYONLU OCAKLAR





## ■ Yüksek güvenlik

Pişirme yüzeyi daima soğuk kalır çünkü yalnızca tencerenin temas ettiği alan ısınır ve yiyeceklerin pişmesi için gerekli ısıyı iletir.



## ■ Enerji tasarrufu

Franke induksiyonlu ocaklar çeşitli güçlerde elektrik şebekelerine uygundur. Yüksek güçte tesisatlar için 7200W'den 3KW'lık normal bir tesisata sahip olanlar için 2800W'ye kadar Franke'nin yenilikçi induksiyon teknolojisi ile herkes yemek pişirebilir.



## ■ Sliding Touch Kontrol

Yenilikçi sistemler sayesinde, induksiyonlu ocak ile etkileşim hızlı ve sezgilere dayalı hale gelerek kaydırmalı kumanda paneli sayesinde kullanımı belirgin ve hassas şekilde farklılaştırır.



## ■ Hızlı pişirme

İndüksiyon teknolojisi zaman ve enerji tasarrufu anlamına gelir. 2 litre suyun kaynamaya başlaması için 3 dakika yeterlidir. Ayrıca, enerjinin %90'ı ısıya dönüşerek ısı kaybını engeller ve yüksek etkinlik standardı sağlar.



## ■ Flex pişirme alanı



Yeni pişirme alanı Flex farklı pişirme gereksinimlerine uyum sağlar. Çok geniş tek bir alan olarak kullanılabilir veya daha küçük iki bağımsız alana bölünebilir. İndüksiyonlu ocağa uyumlu ve farklı boyuttaki tencere kullanımına imkan verir.

## ■ Hijyen ve temizlik

Her zaman soğuk olan yüzey, dökülen sıvıların kristalleşmesini engelleyerek temizlik işlemlerini kolaylaştırır. Kusursuz bir temizlik için, nemli bir bez veya bir sünger yeterlidir.



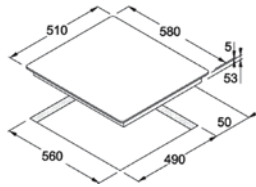

**FH 604-1E 4I T PWL**

**Black Glass  
Inox ön bant**

**108.0266.463**

**Montaj tipi  
Kontrol paneli  
Göz sayısı**

Tezgah üstü  
Dokunmatik  
4 (İndüksiyonlu)  
2 x Ø 145 mm. 1200 W  
2 x Ø 210 mm. 1500 W

**Ebat  
Montaj ölçüsü  
Özellik**

580x510x53 mm  
560x490 mm  
9 kademeli ısı ayarı sıcak yüzey göstergesi,  
timer, çocuk kilidi  
Minimum 60 cm

**Alt Dolap ölçüsü**

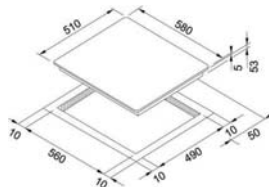
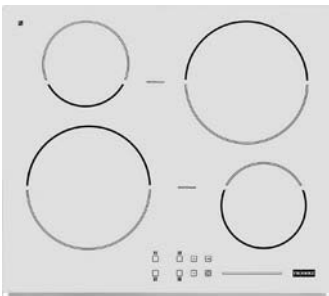

**FH 604 1E 4I T PWL WH**

**White Glass  
Inox ön bant**

**108.0290.070**

**Montaj tipi  
Kontrol paneli  
Göz sayısı**

Tezgaha üstü  
Dokunmatik  
4 (İndüksiyonlu)  
2x Ø 145mm 1200W  
2x Ø 210mm 1500W

**Ebat  
Montaj ölçüsü  
Özellik**

580x510 mm  
560x490 mm  
9 kademeli ısı ayarı sıcak yüzey göstergesi,  
timer, çocuk kilidi  
Minimum 60 cm

**Alt Dolap ölçüsü**



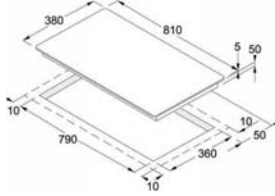

**FHBP 803 3I T XS**

**Black Glass**  
**Inox ön bant**

**108.0181.161**

**Montaj tipi**  
**Kontrol paneli**  
**Göz sayısı**

Tezgah üstü  
Dokunmatik  
3 (İndüksiyonlu)  
1x Ø 160 mm, 1400 W, 1x Ø 210 mm 2300W hızlı ısınma (booster : 3000 W)  
1x Ø 270 mm, 2300 W hızlı ısınma (booster : 3000 W)

**Ebat**  
**Montaj ölçüsü**  
**Özellik**

810x380x55 mm  
790x360x50 mm  
9 kademeli ısı ayarı, sıcak yüzey göstergesi otomatik hızlı ön ısıtma, timer, çocuk kilidi.

**Alt Dolap ölçüsü**

Minimum 80 cm

**Crystal-Flex**

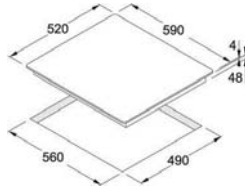
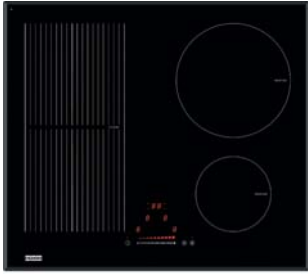

**FHCR 604 2I 1 FLEXI T PWL**

**Black Glass**

**108.0377.087**

**Montaj tipi**  
**Kontrol paneli**  
**Göz sayısı**

Tezgah üstü  
Sliding Touch Kontrol  
4 (İndüksiyonlu)  
1 Flex pişirme alanı  
1x Ø 175mm 1400W Booster 2000W (Flex Zone 450x210)  
1x Ø 175mm 1400W (Flex Zone 450x210)  
1x Ø 215mm 2300W Booster 3000W  
1x Ø 175mm 1400W

**Ebat**  
**Montaj ölçüsü**  
**Özellik**

590x520 mm  
560x490x48 mm  
11 kademeli ısı ayarı, sıcak yüzey göstergesi otomatik hızlı ön ısıtma, timer, çocuk kilidi, kaydırmalı kumanda, Flex pişirme alanı

**Alt Dolap ölçüsü**

Minimum 60 cm

**Crystal-Flex**

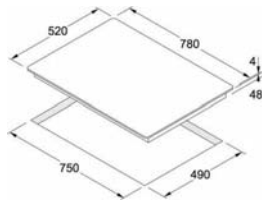

**FH 774 2I 1 FLEXI T PWL**

**Black Glass**

**108.0377.090**

**Montaj tipi**  
**Kontrol paneli**  
**Göz sayısı**

Tezgah üstü  
Sliding Touch Kontrol  
4 (İndüksiyonlu)  
1 Flex pişirme alanı  
1x Ø 175mm 1400W Booster 2000W (Flex Zone 190x170)  
1x Ø 175mm 1400W (Flex Zone 190x170)  
1x Ø 215mm 2300W Booster 3000W  
1x Ø 175mm 1400W

**Ebat**  
**Montaj ölçüsü**  
**Özellik**

780x520 mm  
750x490x48 mm  
11 kademeli ısı ayarı, sıcak yüzey göstergesi otomatik hızlı ön ısıtma, timer, çocuk kilidi kaydırmalı kumanda, Flex pişirme alanı

**Alt Dolap ölçüsü**

Minimum 80 cm

**FLEX PİŞİRME ALANI**



Yeni pişirme alanı Flex farklı pişirme gereksinimlerine uyum sağlar: Çok geniş tek bir alan olarak kullanılabilir veya daha küçük iki bağımsız alana bölünebilir. İndüksiyonlu ocağa uyumlu ve farklı boyuttaki tencerelerin kullanımına imkan verir.





Maris-Flex

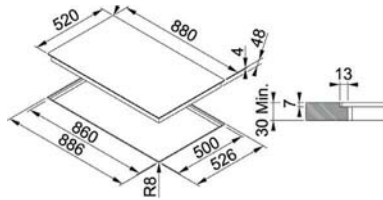
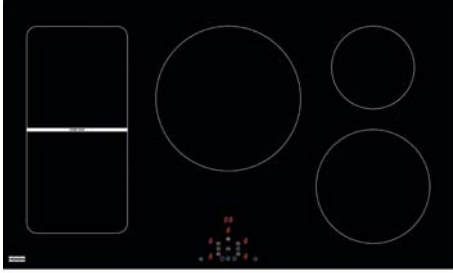

FHMR 905 3I 1 FLEX

Black Glass

108.0390.431

Montaj tipi  
Kontrol paneli  
Göz sayısı

Tezgah üstü  
Dokunmatik  
4 (İndüksiyonlu)  
2 Flex pişirme alanı  
1 x 177 mm. 1400 W  
1 x 205 mm. 2300 W (Booster 3000 W)  
1 x 280 mm. 2300 W (Booster 3000 W)  
1 x 195x400 mm. 2800 W (Booster 3000 W)  
Flex pişirme alanı  
Toplam 7.4 kW  
880x520 mm  
810x490x53 mm  
9 kademeli ısı ayarı sıcak yüzey göstergesi,  
timer, çocuk kilidi, Flexy pişirme alanı  
Minimum 90 cm

Alt Dolap ölçüsü

## FLEX PİŞİRME ALANI



Yeni pişirme alanı Flex farklı pişirme gereksinimlerine uyum sağlar: Çok geniş tek bir alan olarak kullanılabilir veya daha küçük iki bağımsız alana bölünebilir. İndüksiyonlu ocağa uyumlu ve farklı boyuttaki tencerelerin kullanımına imkan verir.



## Mythos-Flex

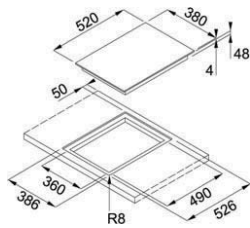

FHMT 302 1 FLEX

Black Glass

108.0391.248

Montaj tipi  
Kontrol paneli  
Göz sayısı

Tezgah üstü  
Sliding Touch Kontrol  
2 (İndüksiyonlu)  
2 Flex pişirme alanı  
1x175 mm, 1400 W, hızlı ısınma (booster : 2000 W)  
1x215 mm, 2300W hızlı ısınma (booster : 3000 W)  
380x520 mm  
360x490 mm  
9 kademeli ısı ayarı, sıcak yüzey göstergesi  
timer, çocuk kilidi, kaydırmalı kumanda,  
Flex pişirme alanı  
Minimum 60 cm

Ebat  
Montaj ölçüsü  
Özellik

Alt Dolap ölçüsü



MYTHOS DAVLUMBAZ İLE TEZGAH  
ÜZERİNDE KUSURSUZ BİRLEŞİM



Katalogumuzun 222 ve 223. sayfasında bulunan 110.0456.716 kodlu Mythos davlumbaz ile kullanılması durumunda yandaki görsele göre 2 adet ocak kullanılabilir.





# KLASİK OCAKLAR

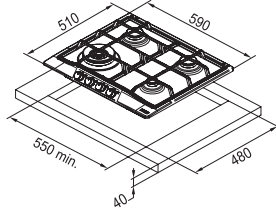

Trendline







FHTL 604 3G TC OA C	Avena		106.0183.080
FHTL 604 3G TC GF C	Grafite		106.0183.092
FHTL 604 3G TC CO C	Romato/Bronz		106.0183.091

Montaj tipi	Tezgah Üstü
Göz sayısı	4 (4 gaz / 1 gözü 3 taçlı wok)
Ebat	590x510 mm
Montaj ölçüsü	550x480 mm
Izgaralar	Döküm ızgara
Gaz giriş yönü	Sağ
Özellik	Gaz emniyet ventili, elektronik ateşleme
Alt Dolap ölçüsü	Minimum 60 cm

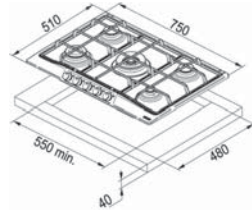

Trendline



FHTL 755 4G TC OA C	Avena		106.0183.106
FHTL 755 4G TC GF C	Grafite		106.0183.110
FHTL 755 4G TC CO C	Romato/Bronz		106.0183.107
FHTL 755 4G TC PW C	Krem		106.0183.111

Montaj tipi	Tezgah Üstü
Göz sayısı	5 (5 gaz / 1 gözü 3 taçlı wok)
Ebat	750x510 mm
Montaj ölçüsü	550x480 mm
Izgaralar	Döküm ızgara
Gaz giriş yönü	Sağ
Özellik	Gaz emniyet ventili, elektronik ateşleme
Alt Dolap ölçüsü	Minimum 60 cm



Avena

R./Bronz

Krem

## Mat krom düğme

112.0188.696  
(4 ad.)

112.0188.693  
(5 ad.)



Trendline modelleri ile uyumludur.  
**opsiyoneldir**

## Mat bronz düğme

112.0188.698  
(4 ad.)

112.0188.697  
(5 ad.)



Trendline modelleri ile uyumludur.  
**opsiyoneldir**



Ocak özelliklerine ait sembollerinin açıklamalarını öğrenmek için arka kapak içindeki tabloyu inceleyebilirsiniz.



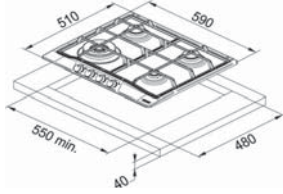

**FHCL 604 3G TC PW C**  
**FHCL 604 3G TC GF C**

**Krem**  
**Grafite**

**106.0271.786**  
**106.0271.788**

**Montaj tipi** Tezgah Üstü  
**Göz sayısı** 4 (4 gaz / 1 gözü 3 taçlı wok)  
**Ebat** 590x510 mm  
**Montaj ölçüsü** 550x480 mm  
**Izgaralar** Döküm ızgara  
**Gaz giriş yönü** Sağ  
**Özellik** Gaz emniyet ventili, elektronik ateşleme  
**Alt Dolap ölçüsü** Minimum 60 cm

Krem ocakta altın renk şeritli krem düğme, grafite ocakta altın renkli düğme mevcuttur

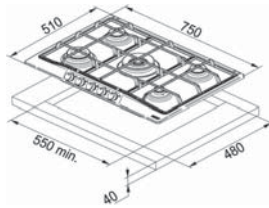

**FHCL 755 4G TC PW C**  
**FHCL 755 4G TC GF C**

**Krem**  
**Grafite**

**106.0271.759**  
**106.0271.781**

**Montaj tipi** Tezgah Üstü  
**Göz sayısı** 5 (5 gaz / 1 gözü 3 taçlı wok)  
**Ebat** 750x510 mm  
**Montaj ölçüsü** 550x480 mm  
**Izgaralar** Döküm ızgara  
**Gaz giriş yönü** Sağ  
**Özellik** Gaz emniyet ventili, elektronik ateşleme  
**Alt Dolap ölçüsü** Minimum 60 cm

Krem ocakta altın renk şeritli krem düğme, grafite ocakta altın renkli düğme mevcuttur



## Classicline Cam Seramik

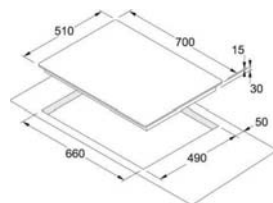

**FHCL 704 4C M PW**  
**FHCL 704 4C M GF**

**Krem**  
**Grafite**

**108.0302.173**  
**108.0302.178**

**Montaj tipi** Tezgah üstü  
**Kontrol paneli** Düğmeli  
**Göz sayısı** 4 (Elektrikli)  
2x Ø140 mm 1200W, 1x Ø180 / 120 mm 1700/700 W 1x Ø180 mm 1800W  
**Ebat** 700x510x40 mm  
**Montaj ölçüsü** 660x490x30 mm  
**Özellik** Sıcak yüzey göstergesi, Dairesel bir çift halka brülörü  
**Alt Dolap ölçüsü** Minimum 60 cm

Krem ocakta altın renk şeritli krem düğme, grafite ocakta altın renkli düğme mevcuttur





# FIRINLAR

---

*Make  
it  
Wonderful*





# FRANKE FIRININI SEÇ

Farklı yemek türlerine göre özenle tasarlanmış pişirme programları sayesinde profesyonel sunumlar.



## ■ Dizayn ve teknoloji

Teknoloji ve tasarım Franke fırınlarda bir araya geldi. Profesyonel ve iyi düşünülmüş detaylar her kullanıcıyı mükemmel sonuçlarla buluşturur. Franke'nin değerlerini yansıtan bir koleksiyon; fonksiyonellik, kullanım güvenliği, enerji tasarrufu ve çevreci yaklaşımını bir arada sunar.



## Enerji sınıfındaki benzersiz ürünler

Franke DCT fırınlar A++ enerji sınıfına sahip tek ürünlerdir. Bu performans Avrupa standartlarına göre en yüksek sınıflandırmaya girmektedir.

Özel DCT teknolojisi ve yeni geniş hacimli tasarım A++ sınıfındaki fırınların ayırtıcı özellikleridir.



Franke fırınlar sahip oldukları yüksek teknolojiye paralel olarak önemli özellikler içerir. Bunlardan birisi de kullandığı "A" sınıfı enerji düzeyidir.

## ■ Patentli Klips Sistemi

Modele göre sökülebilir cam iç kapağı bulunan fırınlarda Franke patentli klips sistemi ile iç cam kolaylıkla çıkarılabilir ve temizlenip takılabilir.

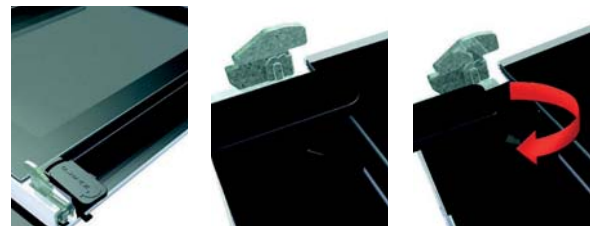



## ■ TFT dokunmatik ekran

TFT dokunmatik ekran optimum okunabilirliği sayesinde fırının tüm fonksiyonlarının basit ve sezgilere dayalı şekilde yönetilmesine izin verir. Renkli ekran aynı zamanda estetik bir verimlilik de sağlar.



## ■ Soft opening/soft close (yavaş ve sessiz açma/kapama)

Franke fırınların kapanma sistemi, kapağın hareketini yavaşlatarak açma ve kapama işlemlerini kolaylaştıran özel bir menteşe ile donatılmıştır.

## ■ Teleskopik raylar

Yenilikçi teleskopik raylar sayesinde, tepsiler kontrol etmek için fırından basit ve güvenli bir şekilde rayların sağladığı ergonomi ile kolaylıkla çekilir.

## ■ Geniş iç hacim

74 litreye kadar hacime sahip modeller mevcuttur. Bu geniş hacimli Franke fırınlar aynı anda dört yemeği pişirmeye izin vererek belirgin bir enerji ve zaman tasarrufu da sağlar.

## ■ Soğuk kapı



Isıyı yansıtan birden fazla kapı camı özel bir şekilde üst üste konulmuş camlardan oluşmaktadır. Bu sayede ısı kaybını engelleyen bir bariyer yaratılır.

Fırın içi sıcaklık korunur ve enerji tüketimi azaltılır. Bu sistem dış kapının soğuk kalmasını sağlar.

# DCT

Dynamic Cooking Technology

## Mutfakta devrim

Özel DCT (dynamic cooking technology - dinamik pişirme teknolojisi) ile, Franke profesyonel ve evde pişirmede devrim yaratmaktadır.



Low Energy fonksiyonu ile  
Sadece  
**1**  
kW

DÜŞÜK ENERJİLİ ÖZEL PROGRAMLAR



**%21 Enerji tasarrufu**

DCT teknolojisi 1 kW'lık güç ile herhangi bir türdeki yemeğin pişmesine olanak sağlar. Bu şekilde 3 kW'lık mevcut güç içinde kalarak birden fazla elektrikli alet aynı anda kullanılabilir, ayrıca alternatif ve yenilenebilir kaynaklardan elde edilen enerjiden tam anlamıyla yararlanır.



**Komple Menü;** % 50 enerji tasarrufu ile bir saatten daha kısa bir sürede eksiksiz bir menüyü mükemmel şekilde pişirmek için tasarlanmış özel bir program. Soğuk fırına üç veya dört tepside eş zamanlı olarak konulan yiyecekler, aromalarını ve lezzetlerini kaybetmeden pişerler.



**Vejetaryen menü;** Sebze ve tahıl bazlı hafif bir menüyü tercih edenlere özel tarifleri içeren tam bir menü programıdır.



**Wellness programı;** Yiyeceklerin besin değerlerini koruyarak, et, balık, sebze ve tatlı tariflerini daha uzun sürede tamamen doğal şekilde pişirmeye izin veren özel pişirme programı.



**Pizza Plus menüsü;** Üç veya dört pizzayı aynı anda pişirmek ve fırından çıkar çıkmaz aynı anda tatmak için özel bir program.



**Otomatik tarifler (Cook Book);** Basit şekilde ve mükemmel sonuçlarla pişirmek için 120'den fazla tarif içeren bir yemek kitabı özelliği ile kumanda panelinden yiyeceklere uygun pişirme süresi, sıcaklık ve fonksiyon otomatik olarak seçilir.



## Kısa pişirme süreleri

DCT teknolojisinde fırını önceden ısıtmak gerekmez. Girişteki soğuk hava akkor ağdan geçerek anında sıcak havaya dönüşür ve pişirme süreleri geleneksel fırınlara kıyasla ortalama %25 azalır.

## Telli reaktif rezistanslar

Franke, geleneksel plaka elektrik rezistanslarını, elektronik kontrollü havayı çok hızlı ısıtan son derece reaktif, çıplak telli rezistanslarla değiştirdi. Bu sayede, rezistansların tellerinden oluşan ağ, etkili bir termik değişimi garanti ederek çok hızlı şekilde havayı ısıtıyor.



## Pişirme mükemmelliği

Eşsiz DCT teknolojisi sayesinde ısı, yanma riski, tatların ve kokuların karışma riski olmaksızın gıdalarda mükemmel bir pişmeyi garanti ederek fırının içinde optimum şekilde dağılır.





# FIRINLAR

NEW GLASS LINEAR	176-179
SMART	180-181
CRYSTAL LINE STEEL	182-183
CRYSTAL LINE WHITE	184
CRYSTAL LINE BLACK	185
CRYSTAL	186-187
DESIGN PLUS / KUZİNE	188
TRENDLINE	189
COUNTRY FLAT	190
CLASSICLINE	191

## MİKRODALGALAR

ELEKTRONİK	192
CRYSTAL LINE MİKRODALGA	193
CRYSTAL MİKRODALGA	193
SMART 45 cm MİKRODALGA	194
CLASSICLINE MİKRODALGA	195

## TEKNİK ÇİZİMLER

196-197

## KOMBİ MİKRODALGA FIRIN

SMART 45 cm	194
-------------	-----

## ISITMA ÇEKMECESİ

194





**GN 82 M NT XS**

**Inox**



**116.0494.143**

**Enerji sınıfı**  
**Kumanda paneli**  
**Genişlik**  
**İç hacim**  
**Program sayısı**  
**Aksesuar**  
**Ray özelliği**

A  
Mekanik  
60 cm  
60 lt.  
7  
2 tepsi, 1 ızgara, 1 tepsi içi ızgara dahil  
1 tepsi veya 1 ızgara için opsiyonel teleskopik ray (112.0494.291)  
Bir fırında max. 3 adet kullanılabilir  
2 camlı fırın kapağı ile "cool door" özelliği  
Multifonksiyonel, pişirme sonu programlama ve sesli uyarı  
Push Pull gömülebilir düğmeler  
Kolay sökülebilir cam iç kapak ile kolay temizleme,  
Kolay sökülebilir yan tel raflar, çocuk kilidi  
İç aydınlatma, "Quick Clean" emaye iç paneller

**Kapı**  
**Ek özellikler**



**GN 86 M NT XS**

**Inox**



**116.0494.144**

**Enerji sınıfı**  
**Kumanda paneli**  
**Genişlik**  
**İç hacim**  
**Program sayısı**  
**Aksesuar**  
**Ray özelliği**

A  
Dijital  
60 cm  
60 lt.  
7  
2 tepsi, 1 ızgara, 1 tepsi içi ızgara dahil  
1 tepsi veya 1 ızgara için opsiyonel teleskopik ray (112.0494.291)  
Bir fırında max. 3 adet kullanılabilir  
2 camlı fırın kapağı ile "cool door" özelliği  
Multifonksiyonel, pişirme sonu programlama ve sesli uyarı  
Push Pull gömülebilir düğmeler  
Kolay sökülebilir cam iç kapak ile kolay temizleme,  
Kolay sökülebilir yan tel raflar, çocuk kilidi  
İç aydınlatma, "Quick Clean" emaye iç paneller

**Kapı**  
**Ek özellikler**



## UYUMLU MİKRODALGA ALTERNATİFİ



**FMW 250 GL G XS**

**Inox**



**131.0361.521**

Detaylı ürün bilgisi katalog sayfa 192



**GN 86 M NT BK** **Black Glass**  **116.0494.145**

**Enerji sınıfı**  
**Kumanda paneli**  
**Genişlik**  
**İç hacim**  
**Program sayısı**  
**Aksesuar**  
**Ray özelliği**

A  
Dijital  
60 cm  
60 lt.  
7  
2 tepsi, 1 ızgara, 1 tepsi içi ızgara dahil  
1 tepsi veya 1 ızgara için opsiyonel teleskopik ray (112.0494.291)  
Bir fırında max. 3 adet kullanılabilir  
2 camlı fırın kapağı ile "cool door" özelliği  
Multifonksiyonel, pişirme sonu programlama ve sesli uyarı  
Push Pull gömülebilir düğmeler  
Kolay sökülebilir cam iç kapak ile kolay temizleme,  
Kolay sökülebilir yan tel raflar, çocuk kilidi  
İç aydınlatma, "Quick Clean" emaye iç paneller

**Kapı**  
**Ek özellikler**



UYUMLU MİKRODALGA ALTERNATİFİ



**FMW 250 CR C** **Pure Black Glass**  **131.0319.449**

Detaylı ürün bilgisi katalog sayfa 193



**GN 86 M NT WH** **White Glass**  **116.0494.146**

**Enerji sınıfı**  
**Kumanda paneli**  
**Genişlik**  
**İç hacim**  
**Program sayısı**  
**Aksesuar**  
**Ray özelliği**

A  
Dijital  
60 cm  
60 lt.  
7  
2 tepsi, 1 ızgara, 1 tepsi içi ızgara dahil  
1 tepsi veya 1 ızgara için opsiyonel teleskopik ray (112.0494.291)  
Bir fırında max. 3 adet kullanılabilir  
2 camlı fırın kapağı ile "cool door" özelliği  
Multifonksiyonel, pişirme sonu programlama ve sesli uyarı  
Push Pull gömülebilir düğmeler  
Kolay sökülebilir cam iç kapak ile kolay temizleme,  
Kolay sökülebilir yan tel raflar, çocuk kilidi  
İç aydınlatma, "Quick Clean" emaye iç paneller

**Kapı**  
**Ek özellikler**



UYUMLU MİKRODALGA ALTERNATİFİ



**FMW 250 CR G WH** **White Glass**  **131.0264.332**

Detaylı ürün bilgisi katalog sayfa 193





GN 96 M T XS Black Glass / Inox

116.0494.148

**Enerji sınıfı**  
**Kumanda paneli**  
**Genişlik**  
**İç hacim**  
**Program sayısı**  
**Aksesuar**  
**Ray özelliği**  
**Kapı**  
**Ek özellikler**

A  
Dijital  
60 cm  
60 lt.  
8  
2 tepsi, 1 ızgara, 1 tepsi içi ızgara dahil  
2 sıra teleskopik ray dahil  
3 camlı fırın kapağı ile "cool door" özelliği  
Multifonksiyonel, pişirme sonu programlama ve sesli uyarı  
Push Pull gömülebilir düğmeler  
Kolay sökülebilir cam iç kapak ile kolay temizleme,  
Kolay sökülebilir yan tel raflar, çocuk kilidi  
İç aydınlatma, "Quick Clean" emaye iç paneller  
Buharlı temizleme özelliği



## UYUMLU MIKRODALGA ALTERNATİFİ



FMW 250 GL G XS Inox

131.0361.521

Detaylı ürün bilgisi katalog sayfa 192

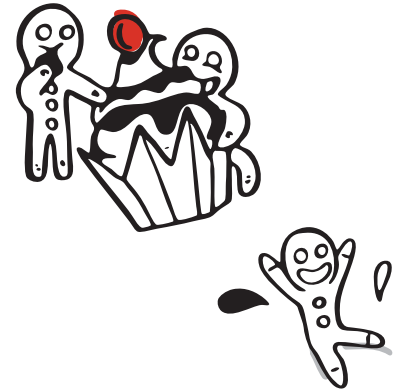



FMO 46 SM 71 XS

Inox



116.0181.164

Enerji sınıfı  
Kumanda paneli  
Genişlik  
İç hacim  
Program sayısı  
Aksesuar  
Kapı  
Ek özellikler

A  
Mekanik  
60 cm  
37 lt. mini fırın  
8  
1 ızgara, 1 derin tepsi dahil  
3 camlı fırın kapağı ile "cool door" özelliği  
Pişirme sonu programlama ve sesli uyarı  
İç aydınlatma, "Quick Clean" emaye iç paneller



SM 62 M XS 2L

Inox



116.0373.507

Enerji sınıfı  
Kumanda paneli  
Genişlik  
İç hacim  
Program sayısı  
Aksesuar  
Kapı  
Ek özellikler

A  
Mekanik  
60 cm  
59 lt.  
6  
1 ızgara, 1 tepsi dahil  
2 camlı fırın kapağı ile "cool door" özelliği  
Pişirme sonu programlama ve sesli uyarı  
Patentli klips sistemi sayesinde sökülebilir cam iç kapak  
İç aydınlatma, "Quick Clean" emaye iç paneller





SM 66 M XS 2L

Inox



116.0373.504

Enerji sınıfı  
Kumanda paneli  
Genişlik  
İç hacim  
Program sayısı  
Aksesuar  
Kapı  
Ek özellikler

A  
Dijital  
60 cm  
59 lt.  
6  
1 ızgara, 1 tepsi dahil  
2 camlı fırın kapağı ile "cool door" özelliği  
Pişirme sonu programlama ve sesli uyarı  
Patentli klips sistemi sayesinde sökülebilir cam iç kapak  
İç aydınlatma, "Quick Clean" emaye iç paneller



SM 981 M XS

Inox



116.0152.145

Enerji sınıfı  
Kumanda paneli  
Genişlik  
İç hacim  
Program sayısı  
Özel programlar

A  
Dijital  
60 cm  
66 lt.  
12  
Komple menüler fonksiyonunda aynı anda 4 farklı yemek pişirebilme özelliği, Sağlıklı pişirme "wellness" özelliği, "Quick Cooking" pizza programı  
"Multi power" fanlı pişirme programı, "Soft cooking" pişirme programı  
1 ızgara, 2 tepsi dahil (1 derin, 1 sıg)  
3 camlı fırın kapağı ile "cool door" özelliği  
Pişirme sonu programlama ve sesli uyarı  
Patentli klips sistemi sayesinde sökülebilir cam iç kapak  
Elektronik termostat, geliştirilmiş elektronik programlama  
İç aydınlatma, "Quick Clean" emaye iç paneller

Aksesuar  
Kapı  
Ek özellikler



SM 981 P XS (pyrolitic) Inox

Inox



116.0152.150

Enerji sınıfı  
Kumanda paneli  
Genişlik  
İç hacim  
Program sayısı  
Özel programlar

A  
Dijital  
60 cm  
59 lt.  
11  
Komple menüler fonksiyonunda aynı anda 4 farklı yemek pişirebilme özelliği, Sağlıklı pişirme "wellness" özelliği, "Quick Cooking" pizza programı  
"Soft cooking" pişirme programı  
1 ızgara, 2 tepsi dahil (1 derin, 1 sıg)  
4 camlı fırın kapağı ile "cool door" özelliği  
Pişirme sonu programlama ve sesli uyarı  
Patentli klips sistemi sayesinde sökülebilir cam iç kapak  
Elektronik termostat, geliştirilmiş elektronik programlama  
İç aydınlatma, "Pyrolitic" otomatik kendi kendini temizleme özelliği

Aksesuar  
Kapı  
Ek özellikler



## UYUMLU MIKRODALGA ALTERNATİFLERİ



FMW 250-G XS Inox



131.0264.301

Detaylı ürün bilgisi katalog sayfa 192



FMW 46 SM C XS Inox



131.0319.450

Kombi mikrodalga  
Detaylı ürün bilgisi katalog sayfa 194



FMW 380 SM G XS Inox



131.0250.859

Detaylı ürün bilgisi katalog sayfa 194







**CR 913 M XS DCT TFT** Inox + Mirror Nero  **116.0374.297**

**Enerji sınıfı**  
**Kumanda paneli**  
**Genişlik**  
**İç hacim**  
**Program sayısı**  
**Özel programlar**

A++  
TFT dokunmatik ekran  
60 cm  
74 lt.  
18  
"Multipower" fanlı pişirme programı  
"Quick Cooking" pizza programı  
"Komple Menüler" fonksiyonu ile aynı anda 4 farklı yemeği pişirebilme özelliği, 121 farklı yemek menüsü, Sağlıklı pişirme "Wellness" özelliği, "Soft Cooking" pişirme programı  
2 ızgara, 2 tepsi dahil (1 derin, 1 sıg)  
2 sıra teleskopik ray dahil  
3 camlı fırın kapağı ile "cool door" özelliği  
Kumanda panelinden ulaşılan yemek listesi, Heatpin ısı ölçer çubuk, Geliştirilmiş elektronik programlama, elektronik termostat, cam iç kapak  
"Quick Clean" emaye iç cidarlar, 2 halojen iç aydınlatma lambası  
"Soft Close" / "Soft Open" kapı özelliği

**Aksesuar**  
**Ray özelliği**  
**Kapı**  
**Ek özellikler**



**DCT**  
Dynamic Cooking Technology

DÜŞÜK ENERJİLİ ÖZEL PROGRAMLAR  
**WELLNESS** Sağlıklı Pişirme  
**KOMPLE MENÜLER** Komple Menüler  
**PIZZA PLUS** Pizza plus



**CR 982 M XS M DCT TFT** Inox + Mirror Nero  **116.0374.302**

**Enerji sınıfı**  
**Kumanda paneli**  
**Genişlik**  
**İç hacim**  
**Program sayısı**  
**Özel programlar**

A++  
TFT düğmeli ekran  
60 cm  
74 lt.  
18  
"Multipower" fanlı pişirme programı, "Quick Cooking" pizza programı  
"Komple Menüler" fonksiyonu ile aynı anda 4 farklı yemeği pişirebilme özelliği, 121 farklı yemek menüsü, Sağlıklı pişirme "Wellness" özelliği, "Soft Cooking" pişirme programı  
2 ızgara, 2 tepsi dahil (1 derin, 1 sıg)  
1 sıra teleskopik ray dahil  
3 camlı fırın kapağı ile "cool door" özelliği  
Kumanda panelinden ulaşılan yemek listesi, Heatpin ısı ölçer çubuk, Geliştirilmiş elektronik programlama, elektronik termostat, cam iç kapak  
"Quick Clean" emaye iç cidarlar, 2 halojen iç aydınlatma lambası  
"Soft Close" / "Soft Open" kapı özelliği

**Aksesuar**  
**Ray özelliği**  
**Kapı**  
**Ek özellikler**



**DCT**  
Dynamic Cooking Technology

DÜŞÜK ENERJİLİ ÖZEL PROGRAMLAR  
**WELLNESS** Sağlıklı Pişirme  
**KOMPLE MENÜLER** Komple Menüler  
**PIZZA PLUS** Pizza plus

## UYUMLU MIKRODALGA ALTERNATİFİ



**FMW 250 CS2 G XS** Inox + Mirror Nero  **131.0391.303**

Detaylı ürün bilgisi katalog sayfa 193

### Crystal Steel Isıtma Çekmecesı



**DRW CS 14 XS** Inox  **112.0347.101**

Sıcak tutma ve ısıtma çekmecesı  
Detaylı ürün bilgisi katalog sayfa 194





**Enerji sınıfı**  
**Kumanda paneli**  
**Genişlik**  
**İç hacim**  
**Program sayısı**  
**Özel programlar**

**Aksesuar**  
**Ray özelliği**  
**Kapı**  
**Ek özellikler**



**CR 913 M WH DCT TFT** **Cristallo Bianco** **116.0374.296**

A++  
TFT dokunmatik ekran  
60 cm  
74 lt.  
18  
"Multipower" fanlı pişirme programı  
"Quick Cook" pizza programı, "Soft Cooking" pişirme programı  
Komple Menüler" fonksiyonunda aynı anda 4 farklı yemek pişirebilme özelliği, 121 farklı yemek menüsü, Sağlıklı pişirme "wellness" özelliği  
2 ızgara, 2 tepsi (1 derin, 1 sıg)  
2 sıra teleskopik ray dahil  
3 camlı fırın kapağı ile "cool door" özelliği  
Kumanda panelinden ulaşılan yemek listesi  
Heatpin ısı ölçer çubuk, Geliştirilmiş elektronik programlama, Elektronik termostat, cam iç kapak, "Quick Clean" emaye iç cidarlar, 2 halojen iç aydınlatma lambası, "Soft Close" / "Soft Open" kapı özelliği

**DCT**  
Dynamic Cooking Technology

DÜŞÜK ENERJİLİ ÖZEL PROGRAMLAR

WELLNESS

Sağlıklı Pişirme

Komple Menüler

Pizza Plus

Pizza Plus

Pizza Plus



**Enerji sınıfı**  
**Kumanda paneli**  
**Genişlik**  
**İç hacim**  
**Program sayısı**  
**Özel programlar**

**Aksesuar**  
**Ray özelliği**  
**Kapı**  
**Ek özellikler**



**CR 982 M WH M DCT TFT** **Cristallo Bianco** **116.0374.301**

A++  
TFT düğmeli ekran  
60 cm  
74 lt.  
18  
"Multipower" fanlı pişirme programı, "Quick Cooking" pizza programı  
"Komple Menüler" fonksiyonu ile aynı anda 4 farklı yemeği pişirebilme özelliği, 121 farklı yemek menüsü, Sağlıklı pişirme "Wellness" özelliği,  
"Soft Cooking" pişirme programı  
2 ızgara, 2 tepsi (1 derin, 1 sıg)  
1 sıra teleskopik ray dahil  
3 camlı fırın kapağı ile "cool door" özelliği  
Geliştirilmiş elektronik programlama, elektronik termostat, cam iç kapak  
"Quick Clean" emaye iç paneller, 2 halojen iç aydınlatma lambası  
"Soft Close" / "Soft Open" kapı özelliği

**DCT**  
Dynamic Cooking Technology

DÜŞÜK ENERJİLİ ÖZEL PROGRAMLAR

WELLNESS

Sağlıklı Pişirme

Komple Menüler

Pizza Plus

Pizza Plus

Pizza Plus

## UYUMLU MIKRODALGA ALTERNATİFİ



**FMW 250 CR2 G WH** **Cristallo Bianco** **131.0391.302**

Detaylı ürün bilgisi katalog sayfa 193





**Enerji sınıfı**  
**Kumanda paneli**  
**Genişlik**  
**İç hacim**  
**Program sayısı**  
**Özel programlar**

**Aksesuar**  
**Ray özelliği**  
**Kapı**  
**Ek özellikler**



**CR 913 M BK DCT TFT** **Cristallo Nero**  **116.0374.295**

A++  
TFT dokunmatik ekran  
60 cm  
74 lt.  
18  
"Multipower" fanlı pişirme programı  
"Quick Cook" pizza programı, "Soft Cooking" pişirme programı  
Komple Menüler" fonksiyonunda aynı anda 4 farklı yemek pişirebilme özelliği, 121 farklı yemek menüsü, Sağlıklı pişirme "wellness" özelliği  
2 ızgara, 2 tepsi (1 derin, 1 sıg)  
2 sıra teleskopik ray dahil  
3 camlı fırın kapağı ile "cool door" özelliği  
Kumanda panelinden ulaşılan yemek listesi  
Heatpin ısı ölçer çubuk, Geliştirilmiş elektronik programlama, Elektronik termostat, cam iç kapak, "Quick Clean" emaye iç cidarlar, 2 halojen iç aydınlatma lambası, "Soft Close" / "Soft Open" kapı özelliği

**DCT**  
Dynamic Cooking Technology

DÜŞÜK ENERJİLİ ÖZEL PROGRAMLAR



**Enerji sınıfı**  
**Kumanda paneli**  
**Genişlik**  
**İç hacim**  
**Program sayısı**  
**Özel programlar**

**Aksesuar**  
**Ray özelliği**  
**Kapı**  
**Ek özellikler**



**CR 982 M BK M DCT TFT** **Cristallo Nero**  **116.0374.300**

A++  
TFT düğmeli ekran  
60 cm  
74 lt.  
18  
"Multipower" fanlı pişirme programı, "Quick Cooking" pizza programı  
"Komple Menüler" fonksiyonu ile aynı anda 4 farklı yemeği pişirebilme özelliği, 121 farklı yemek menüsü, Sağlıklı pişirme "Wellness" özelliği, "Soft Cooking" pişirme programı  
2 ızgara, 2 tepsi (1 derin, 1 sıg)  
1 sıra teleskopik ray dahil  
3 camlı fırın kapağı ile "cool door" özelliği  
Geliştirilmiş elektronik programlama, Elektronik termostat, cam iç kapak  
"Quick Clean" emaye iç paneller, 2 halojen iç aydınlatma lambası  
"Soft Close" / "Soft Open" kapı özelliği

**DCT**  
Dynamic Cooking Technology

DÜŞÜK ENERJİLİ ÖZEL PROGRAMLAR



## UYUMLU MİKRODALGA ALTERNATİFİ



**FMW 250 CR2 G BK** **Crystal Nero**  **131.0391.304**

Detaylı ürün bilgisi katalog sayfa 193







CR 66 M BM-1

Mirror Black Glass

116.0182.138

Enerji sınıfı  
Kumanda paneli  
Genişlik  
İç hacim  
Program sayısı  
Aksesuar  
Kapı  
Ek özellikler

A  
Dijital  
60 cm  
59 lt.  
7  
2 ızgara, 1 tepsi  
3 camlı fırın kapağı ile "cool door" özelliği  
Pişirme sonu programlama ve sesli uyarı  
İç aydınlatma, "Quick Clean" emaye iç paneller

A



## UYUMLU MIKRODALGA ALTERNATİFİ



FMW 250 CR G BM

Mirror Black Glass

131.0264.329

Detaylı ürün bilgisi katalog sayfa 193



CR 66 M WH-1

White Glass

116.0182.139

Enerji sınıfı  
Kumanda paneli  
Genişlik  
İç hacim  
Program sayısı  
Aksesuar  
Kapı  
Ek özellikler

A  
Dijital  
60 cm  
59 lt.  
7  
2 ızgara, 1 tepsi  
3 camlı fırın kapağı ile "cool door" özelliği  
Pişirme sonu programlama ve sesli uyarı  
İç aydınlatma, "Quick Clean" emaye iç paneller

A



## UYUMLU MIKRODALGA ALTERNATİFİ

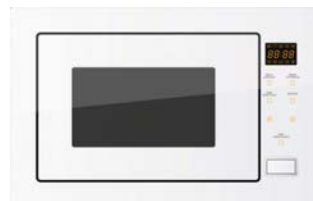

FMW 250 CR G WH

White Glass

131.0264.332

Detaylı ürün bilgisi katalog sayfa 193





## Design Plus - 90 cm



FMXO 86 M XS

Inox

116.0255.248

Enerji sınıfı	A
Kumanda paneli	Dijital
Genişlik	90 cm
İç hacim	71 lt.
Program sayısı	8
Aksesuar	1 ızgara, 1 tepsi
Kapı	3 camlı fırın kapağı ile "cool door" özelliği
Ek özellikler	2 iç aydınlatma lambası Isı yansıtıcı sökülebilir iç cam Çok şişli çevirme



## Kuzine Sauter Line



FCK 9692 EMG XS

Inox

116.0187.176

Fırın özellikleri	
Kumanda paneli	Düğmeli
Genişlik	90 cm
İç hacim	110 lt.
Program sayısı	7
Aksesuar	1 ızgara, 1 tepsi
Ek özellikler	Pişirme sonu programlama ve sesli uyarı İç aydınlatma, "Quick Clean" emaye iç paneller
Ocak özellikleri	
Ebat	900x600 mm
Göz sayısı	6 (6 gaz, 1 gözü 3 taçlı wok)
Özellik	Gaz emniyet ventili, elektronik ateşleme





TL 65 M XS  
TL 65 M PW

Inox  
Krem



116.0183.315  
116.0183.316

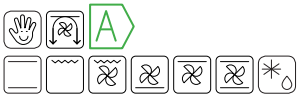

**Enerji sınıfı**  
**Kumanda paneli**  
**Genişlik**  
**İç hacim**  
**Program sayısı**  
**Aksesuar**  
**Kapı**  
**Ek özellikler**

A  
Mekanik (Analog Saat)  
60 cm  
59 lt.  
7  
2 ızgara, 1 tepsi  
3 camlı fırın kapağı ile "cool door" özelliği  
Pişirme sonu programlama ve sesli uyarı  
İç aydınlatma, "Quick Clean" emaye iç paneller





CF 55 M OA / N  
CF 55 M GF / N  
CF 55 M CO / N

Avena  
Grafite  
Romato

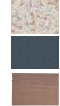

116.0373.513  
116.0373.514  
116.0373.515

Enerji sınıfı	A
Kumanda paneli	Mekanik (Analog Saat)
Genişlik	60 cm
İç hacim	63 lt.
Program sayısı	6
Özel programlar	Multi fonksiyonel, 1 ızgara, 1 tepsi
Aksesuar	2 camlı fırın kapağı, kolay sökülebilir ve temizlenebilir iç cam,
Kapı	Rustik tasarım, mat dore kulp ve düğmeler
Ek özellikler	Analog saatli pişirme sonu programlama "Quick Clean" emaye iç paneller 1 iç aydınlatma lambası

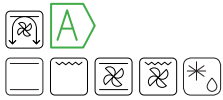







FMW 20 SC G XS

Inox



131.0319.471

Kumanda paneli  
İç hacim  
Aksesuar  
Mikrodalga gücü  
Izgara gücü  
Ek özellikler

Elektronik, kolay kullanım sağlayan tuşlu sistem  
20 lt.  
1 cam döner tepsi, 1 ızgara teli  
1000 watt  
1250 watt  
60 cm genişlik, dijital ekran, ızgara (grill) özelliği, **uygun ölçüsüyle üst mutfak dolaplarına monte edilebilir**, zemine tam gömülü cam döner tepsi, 24,5 cm. çapa kadar kaplarda dönerek pişirme imkanı, otomatik tekrar ısınma özelliği, kombine ızgara ve mikrodalga opsiyonu, çoklu pişirme fonksiyonu, buz çözme, pişirme sonu uyarı özelliği, 95 dakikalık timer, kapı içinde nem önleyici hava akımı, kolay temizlenebilir çelik iç paneller, çocuk kilidi.  
Ebat Y: 388 x G: 595 x D: 343,5 mm

Ebat



FMW 250 GL G XS

Inox



131.0361.521

Kumanda paneli  
İç hacim  
Aksesuar  
Mikrodalga gücü  
Izgara gücü  
Ek özellikler

Elektronik, kolay kullanım sağlayan tuşlu sistem  
25 lt.  
1 cam döner tepsi, 1 ızgara teli  
1000 watt  
900 watt  
60 cm genişlik, dijital ekran, ızgara (grill) özelliği, zemine tam gömülü cam döner tepsi, 31,5 cm. çapa kadar kaplarda dönerek pişirme imkanı, otomatik tekrar ısınma özelliği, kombine ızgara ve mikrodalga opsiyonu, çoklu pişirme fonksiyonu, buz çözme, pişirme sonu uyarı özelliği, 95 dakikalık timer, kapı içinde nem önleyici hava akımı, kolay temizlemek için çelik iç paneller, çocuk kilidi, cam tepsi ve ızgara teli dahil  
Ebat Y: 388 x G: 595 x D: 400 mm

Ebat



FMW 250-G XS

Inox



131.0264.301

Kumanda paneli  
İç hacim  
Aksesuar  
Mikrodalga gücü  
Izgara gücü  
Ek özellikler

Elektronik, kolay kullanım sağlayan tuşlu sistem  
25 lt.  
1 cam döner tepsi, 1 ızgara teli  
1000 watt  
900 watt  
60 cm genişlik, dijital ekran  
Izgara (Grill) özelliği, Zemine tam gömülü cam döner tepsi, 31,5 cm çapa kadar kaplarda dönerek pişirme imkanı, otomatik tekrar ısınma özelliği, kombine ızgara ve mikrodalga opsiyonu, multi-cooking fonksiyonu, buz çözme, pişirme sonu uyarı özelliği, 95 dakikalık timer, kapı içinde nem önleyici hava akımı, kolay temizlemek için çelik iç paneller, çocuk kilidi  
Ebat Y: 388 mm x G: 595 mm x D: 400 mm

Ebat

# CRYSTAL LINE MİKRODALGA



FMW 250 CS2 G XS	Inox + Mirror Nero		131.0391.303
FMW 250 CR2 G BK	Cristallo Nero		131.0391.304
FMW 250 CR2 G WH	Cristallo Bianco		131.0391.302

Kumanda paneli  
Program sayısı  
İç hacim  
Aksesuar  
Mikrodalga gücü  
Izgara gücü  
Ek özellikler

Dokunmatik  
7  
25 lt.  
1 cam döner tepsi, 1 ızgara teli  
900 watt  
1000 watt  
60 cm genişlik, dokunmatik kumanda paneli, Izgara (Grill) özelliği, zemine tam gömülü cam döner tepsi, 31,5 cm çapa kadar kaplarda dönerek pişirme imkanı, otomatik tekrar ısıtma özelliği, kombine ızgara ve mikrodalga opsiyonu, multi-cooking fonksiyonu, buz çözme, pişirme sonu uyarı özelliği, 95 dakikalık timer, kapı içinde nem önleyici hava akımı, kolay temizlemek için çelik iç paneller, çocuk kilidi  
Y: 388 mm x G: 595 mm x D: 400 mm

Ebat

Crystal Line fırınlara uyumlu kumanda paneli



Cristallo Nero



Cristallo Bianco

# CRYSTAL MİKRODALGA



FMW 250 CR G BM	Mirror Black Glass		131.0264.329
FMW 250 CR C	Pure Black Glass		131.0319.449
FMW 250 CR G WH	White Glass		131.0264.332

Kumanda paneli  
Program sayısı  
İç hacim  
Aksesuar  
Mikrodalga gücü  
Izgara gücü  
Ek özellikler

Dokunmatik  
7  
25 lt.  
1 cam döner tepsi, 1 ızgara teli  
900 watt  
1000 watt  
60 cm genişlik, dokunmatik kumanda paneli, Izgara (Grill) özelliği, zemine tam gömülü cam döner tepsi, 31,5 cm çapa kadar kaplarda dönerek pişirme imkanı, otomatik tekrar ısıtma özelliği, kombine ızgara ve mikrodalga opsiyonu, multi-cooking fonksiyonu, buz çözme, pişirme sonu uyarı özelliği, 95 dakikalık timer, kapı içinde nem önleyici hava akımı, kolay temizlemek için çelik iç paneller, çocuk kilidi  
Y: 388 mm x G: 595 mm x D: 400 mm

Ebat

Crystal fırınlara uyumlu kumanda paneli



White Glass



Pure Black Glass

## SMART 45 CM MİKRODALGA

FMW 380 SM G XS

Inox



131.0250.859



Kumanda paneli  
İç hacim  
Program sayısı  
Aksesuar  
Mikrodalga gücü  
Izgara gücü  
Ek özellikler

Dijital  
38 lt.  
3  
1 cam döner tepsi, 1 ızgara teli  
1000 watt  
1500 watt  
32 cm. çapa kadar kaplarda dönerek pişirme imkanı, Çocuk kilidi,  
Kolay temizlenebilir çelik paneller.  
Y: 455 x G: 595 x D: 472 mm

Ebat

## SMART KOMBİ MİKRODALGA

FMW 46 SM C XS

Inox



131.0319.450



Kumanda paneli  
İç hacim  
Aksesuar  
Mikrodalga gücü  
Izgara gücü  
Kombi gücü  
Ek özellikler

Dijital  
32 lt.  
1 cam döner tepsi, 1 ızgara teli, 1 cam fırın tepsisi  
1000 watt  
1500 watt  
1500 watt  
32 cm. çapa kadar kaplarda dönerek pişirme  
imkanı, Kombine pişirme ve mikrodalga opsiyonu, Kombine ızgara ve  
mikrodalga opsiyonu, Hem fırın hem mikrodalga multifonksiyonel fırın  
Buz çözme, Çocuk kilidi, İç aydınlatma, Elmas şekilli reflektör, 90 dk.  
Timer, kapı içinde nem önleyici hava akımı, kolay temizlenebilir iç paneller  
Y: 455 x G: 595 D: 542 mm

Ebat

## CRYSTAL STEEL ISITMA ÇEKMECESİ

DRW CS 14 XS

Inox



112.0347.101



İç hacim  
Yükleme kapasitesi  
Yükseklik  
Isıtma kademesi  
Ek özellikler

20,5 lt.  
15 kg.  
140 mm  
4  
Sıcak tutma ve ısıtma çekmecesini, 80°'ye kadar ulaşılabilen sıcaklık,  
Push-pull dokunmatik çekmece sistemi, 45 cm. ankastru fırın, mikrodalga,  
kombi mikrodalga ürünlerimiz ile kombine edilmesi durumunda 60  
cm. standart kabin ölçüsüne ulaşır.

# CLASSICLINE MİKRODALGA

FMW 380 CL G PW

Krem

131.0302.179

FMW 380 CL G GF

Grafite

131.0302.181



Kumanda paneli  
İç hacim  
Program sayısı  
Aksesuar  
Mikrodalga gücü  
Izgara gücü  
Ek özellikler

Dijital  
38 lt.

3

1 cam döner tepsi, 1 ızgara teli

1000 watt

1500 watt

32 cm. çapa kadar kaplarda dönerek pişirme imkanı, Çocuk kilidi, krem mikrodalgada altın renk şeritli krom düğme, grafite mikrodalgada altın renk düğme

Ebat

Y: 455 x G: 595 x D: 472 mm



Grafite



## NEW GLASS LINEAR

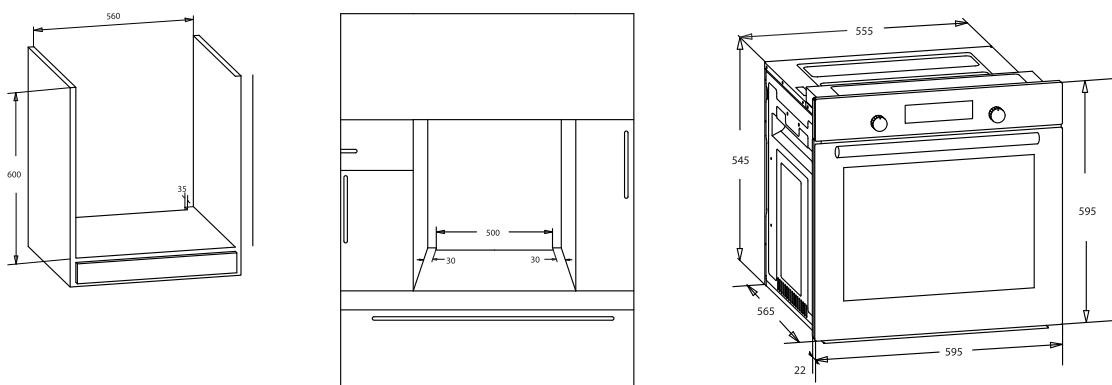

## CRYSTAL LINE BLACK CRSYTL LINE WHITE CRSYTL LINE STEEL

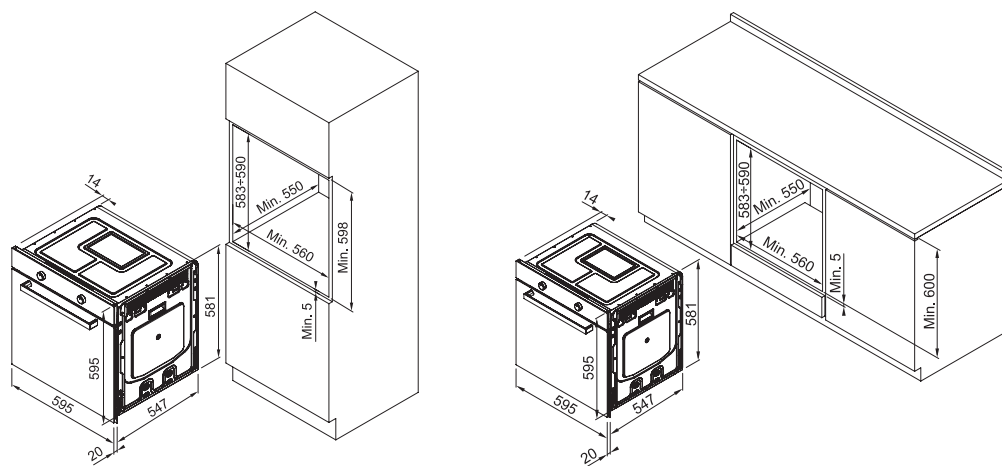

## SMART 981

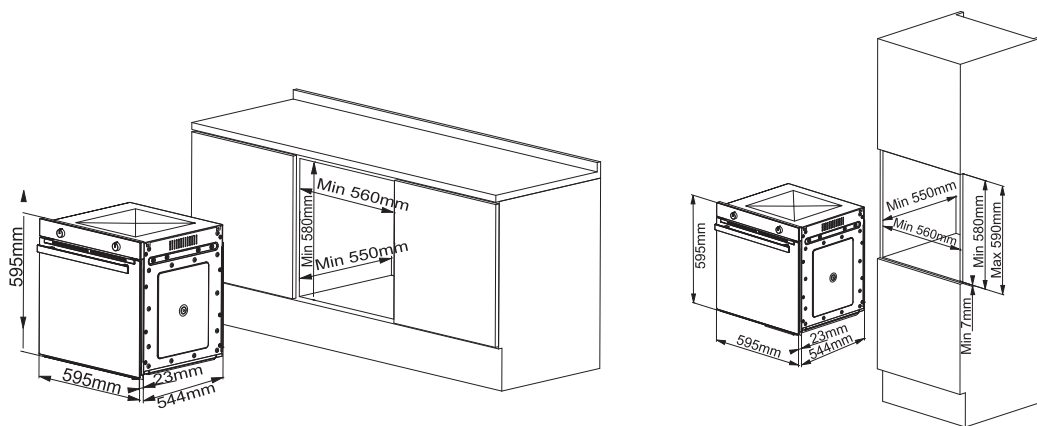

## SMART 62/66 COUNTRY FLAT

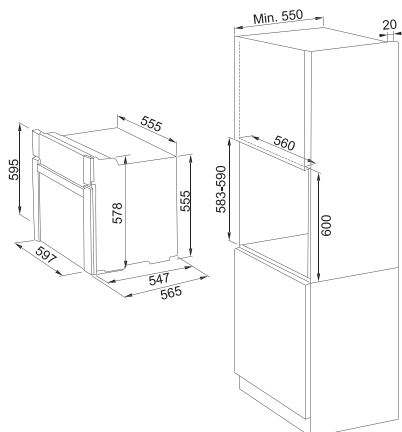

## DESİGN PLUS 90 cm

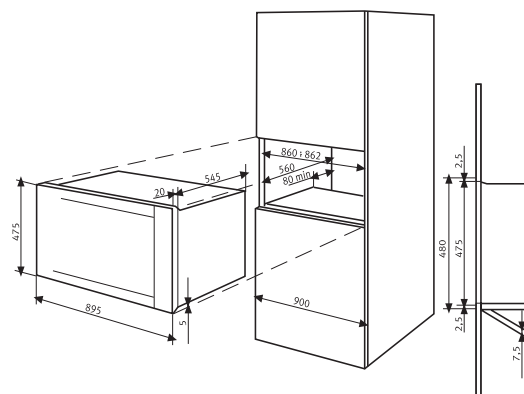

**CRYSTAL 66  
TRENDLINE  
SMART PYROLITIC**

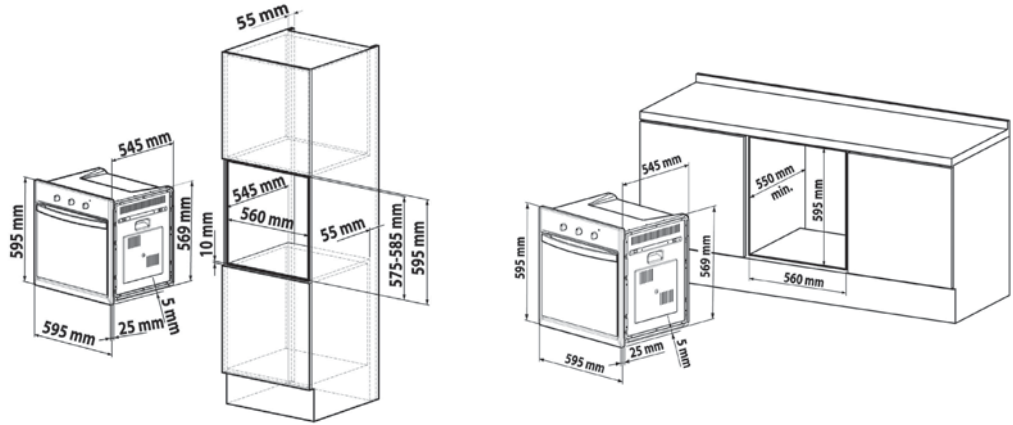

**CRYSTAL LINE MİKRODALGA  
CRYSTAL MİKRODALGA**

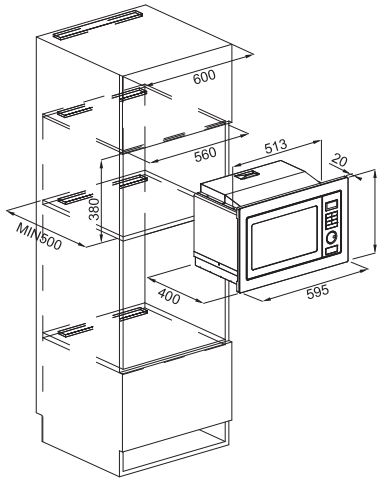

**SMART MİKRODALGA  
CLASSICLINE MİKRODALGA**

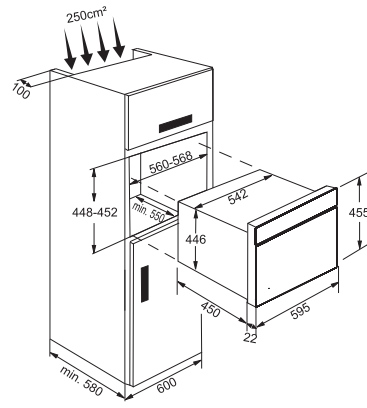

**20 lt. MİKRODALGA FIRIN**

**FMW 46 SM C XS COMBİ**

**FMW 380 SM G XS SMART**

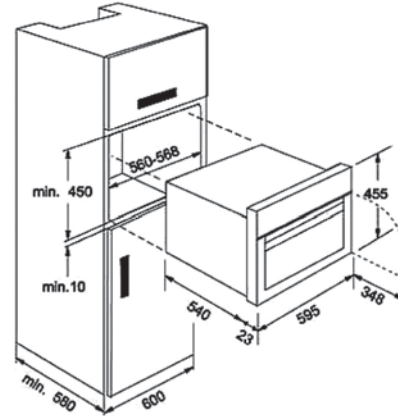
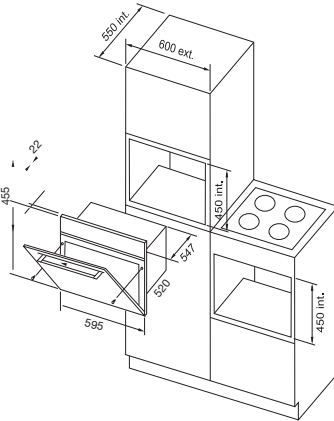
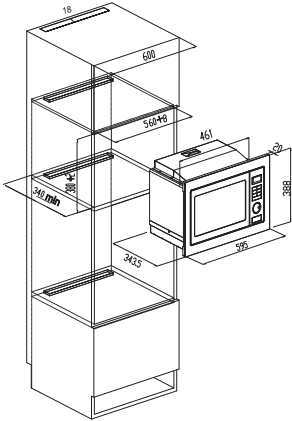

**25 lt. MİKRODALGA FIRIN**

- A - 595 mm
- B - 388 mm
- C - 400 mm
- D - 560 mm
- E - 380 mm
- F - min.500 mm
- G - 10 mm
- H - 10 mm
- I - 20 mm
- J - 45 mm

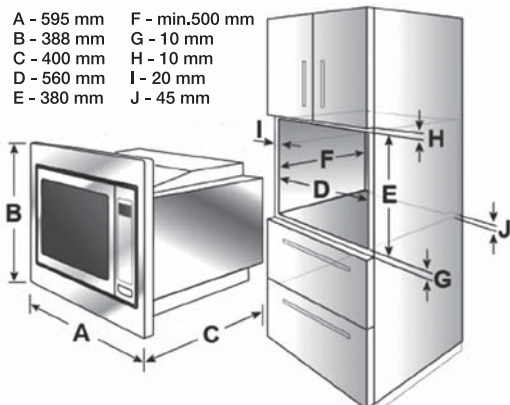

# DAVLUMBAZLAR

---





Make  
it  
Wonderful



# FRANKE DAVLUMBAZINI SEÇ

İşlevsellik aynı zamanda sofistike şıklık anlamına gelir. Franke davlumbazlar mutfak ortamının stilini zaman içinde ön plana çıkarmak ve çok yüksek performans düzeylerini sunmak üzere tasarlanmıştır.

## DOĞRU DAVLUMBAZI SEÇMEK

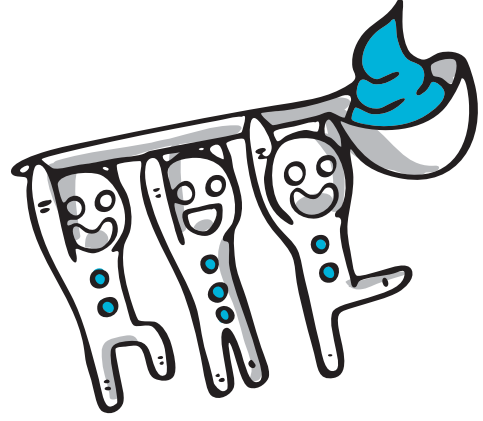

### ■ Baca bağlantılı yada karbon filtreli kullanım

Franke alternatif olarak hem baca bağlantısı hem de karbon filtre ile kullanılabilen versiyonda çalışabilecek davlumbaz ürün serisi sunmaktadır.

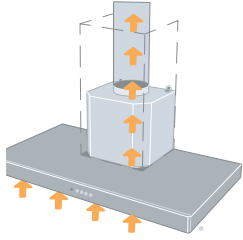

Baca bağlantısı yapılan davlumbazlar koku ve buharı tahliye borusundan dışarı verirken karbon filtreli davlumbazlar filtreden geçirerek ortama temiz şekilde geri verir.

Genel olarak Franke modellerinde hem baca bağlantılı hem de karbon filtreli kullanım bir aradadır.

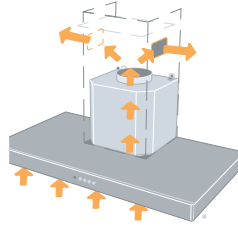

### ■ Çekiş gücü hesaplama

Davlumbazın ideal emiş gücü kabul edilebilir bir gürültü seviyesi ile saatte on hava değişimini sağlamalıdır.

Davlumbazın ortam çekiş yeterliliğini hesaplamak için, odanın hacminin 10 ile çarpılması yeterlidir.

$$\text{m}^3 \text{ İHTİYACI HESAPLAMA} = \text{mutfağın m}^2 \text{ 'si} \times \text{mutfağın yüksekliği} \times 10 \text{ hava değişimi}$$

Örnek: 3 m yüksekliğinde 15 m<sup>2</sup> bir mutfak, en az 450 m<sup>3</sup>/s emiş gücüne sahip davlumbaz gerektirir.

$$15 \text{ m}^2 \times 3 \text{ m} \times 10 = 450 \text{ m}^3/\text{s}$$

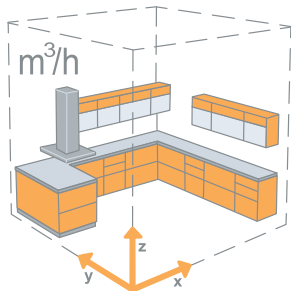

### ■ Doğru kurulum

Davlumbazın doğru kurulumu için bazı kurallara uyulması gerekir:

- Ocak üzerinde davlumbaz ortalarak yerleştirilmelidir.
- Ocak ızgarası ile davlumbaz arasında ki mesafe induksiyonlu ocaklarda en az 55 cm, gazlı ocaklarda en az 65 cm olmalıdır.
- Baca deliğinin konumu ve mesafesi davlumbaza uzak olmamalıdır.

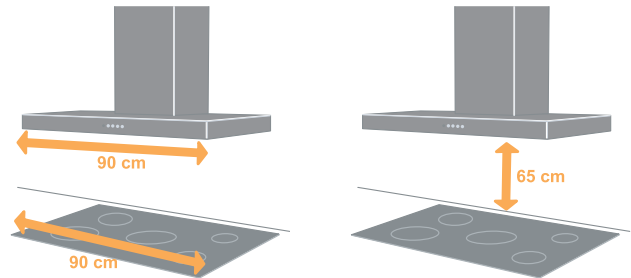



Franke davlumbazların bir çoğu IF yenilik ve tasarım ödülüne layık görülmüştür.

Ödüllü tasarımlar ve yüksek performansları sayesinde mutfaklar Franke davlumbazlar ile nefes alıyor.

## ■ Çevre havalandırması

Birçok Franke davlumbaz modelinde, en ideal verimlilik garantisi veren geliştirilmiş çevre havalandırması sayesinde hava, panelin dar çıkış alanından geçerken hızlanır. Ardından davlumbazın içinde aniden yavaşlar. Böylece algılanan ses %25 oranında azalırken hava özel bir basınca gerek kalmadan kolayca dışarı çıkar.

## ■ Elektronik / dokunmatik kumanda panelleri

Düğmeli, dokunmatik ya da elektronik kumandalar Franke davlumbazlarının tüm fonksiyonlarının basit bir şekilde yönetilmesine izin verir.

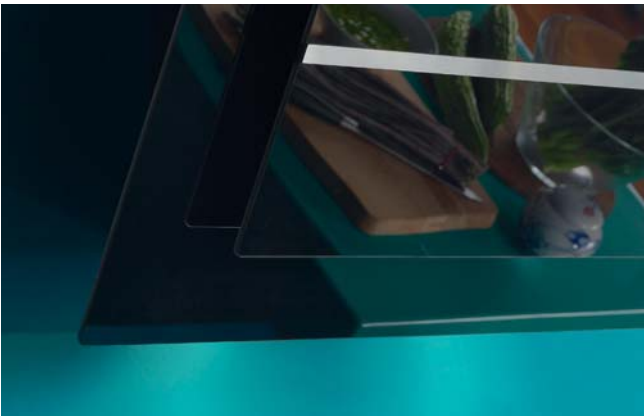





# DAVLUMBAZLAR

ANKASTRE BOX	204
ANKASTRE INCA BOX	204
SÜRGÜLÜ ASPİRATÖR	204
MYTHOS	205
LINFA / GLASS LINEAR / GLASS SOFT	206-207
FORMAT / FORMAT PLUS / CRYSTAL LINE	208
CRYSTAL LINE	209
NEPTUN SLIM	210
MARİS	211
GLASS VERTICAL	212
SMART	213
MARIS VERTICAL	214-215
SINOS	216
MYTHOS	217
MARIS PLUS / SWING	219
CRYSTAL LINE STEEL	220
TUNNEL / NEPTUN KÖŞE	221

## KLASİK DAVLUMBAZLAR

SIRIO/CLASSICLINE/TRENDLINE	222
COUNTRY LONDRA	223
COUNTRY SCOTLAND	223
CLASSIC LORD	223

MYTHOS	224-225
DOWNDRAFT	226

## ADA DAVLUMBAZLAR

GLASS LINEAR / GLASS SOFT / TUNNEL	227
FORMAT 45 / FORMAT PLUS	228
CRYSTAL LINE	229
MARIS CEILING ANKASTRE	230
APOLLO	231
MERCURY	232
MARIS	233





FMY 608 POT WH / 600	White Glass	110.0456.719
FMY 908 POT WH / 900	White Glass	110.0456.720
FMY 608 POT BK / 600	Black Glass	110.0456.717
FMY 908 POT BK / 900	Black Glass	110.0456.718

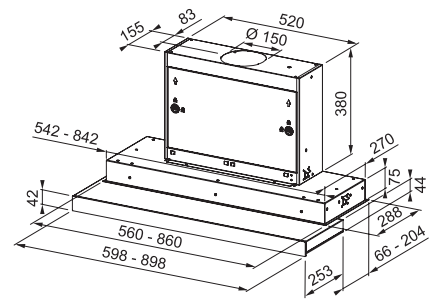

	1	2	3	int.
Aspirasyon Debisi (m <sup>3</sup> /h)	240	370	450	500
Ses (dBA)	58	64	69	70

Kumanda paneli  
Aydınlatma  
Motor gücü  
Hız  
Boru çıkış çapı  
Ek özellikler

Touch Control  
6 Watt'lık 1 LED  
125 W  
3+1  
Ø150 mm / Beraberinde verilen redüksiyon Ø120 mm  
Ankastre Sürgülü, Intensive Speed fonksiyonu, Timer 30 dk. auto stop çalıştırma programı  
Mekan havasının devamlı temizliği için 24 saat boyunca belli aralıklarla davlumbazı çalıştıran 24 saat fonksiyonu, Alüminyum ve karbon filtre dolum uyarısı  
Opsiyonel karbon filtre takılabilir. (112.0479.832 / 60'lık, 112.0479.833 / 90 'lık model için)





# LINFA / GLASS LINEAR / GLASS SOFT

## Linfa



FDL 6065 XS/600  
FDL 9065 XS/900

Inox  
Inox

110.0152.548  
110.0152.549

Kumanda paneli  
Aydınlatma  
Filtre  
Motor gücü  
Hız  
Boru çıkış çapı  
Ek özellikler

Soft touch düğme  
40 Watt'lık 2 lamba  
Alüminyum  
250 W  
3+1  
Ø150 mm / Beraberinde verilen redüksiyon Ø120 mm  
Intensive Speed Fonksiyonu,  
Opsiyonel karbon filtre takılabilir. (112.0016.755)

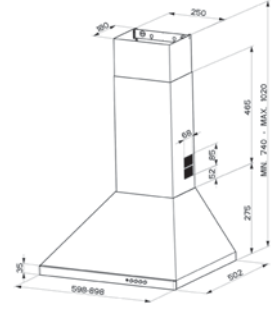

	1	2	3	int.
Aspirasyon Debisi (m <sup>3</sup> /h)	260	405	555	705
Ses (dBA)	44	55	62	67



## Glass Linear



FGL 6015 XS/600  
FGL 7015 XS/700  
FGL 9015 XS/900

Glass/Inox  
Glass/Inox  
Glass/Inox

110.0152.535  
110.0152.537  
110.0152.538

Kumanda paneli  
Aydınlatma  
Filtre  
Motor gücü  
Hız  
Boru çıkış çapı  
Ek özellikler

Soft touch düğme  
20 Watt'lık 2 lamba  
Alüminyum  
145 W  
3  
Ø150 mm / Beraberinde verilen redüksiyon Ø120 mm  
Cam ve Siyah cam alternatifi  
Opsiyonel karbon filtre takılabilir (112.0016.756)

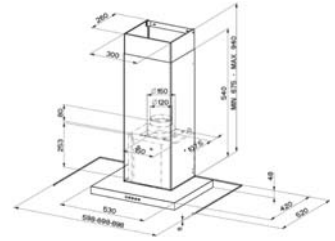

	1	2	3
Aspirasyon Debisi (m <sup>3</sup> /h)	220	320	395
Ses (dBA)	51	60	66



## Glass Soft



FGC 625 XS/600  
FGC 925 XS/900

Glass/Inox  
Glass/Inox

110.0152.531  
110.0152.532

FGC 625 BK/XS/600  
FGC 925 BK/XS/900

Black Glass/Inox  
Black Glass/Inox

110.0152.533  
110.0152.534

Kumanda paneli  
Aydınlatma  
Filtre  
Motor gücü  
Hız  
Boru çıkış çapı  
Ek özellikler

Soft touch düğme  
20 Watt'lık 2 lamba  
Alüminyum  
250 W  
3+1  
Ø150 mm / Beraberinde verilen redüksiyon Ø120 mm  
Cam ve Siyah cam alternatifi,  
Intensive speed fonksiyonu,  
Opsiyonel karbon filtre takılabilir. (112.0016.756)

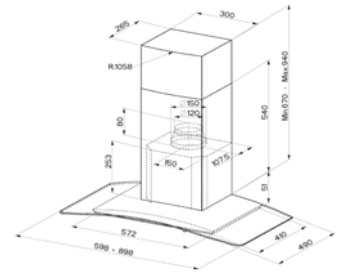

	1	2	3	int.
Aspirasyon Debisi (m <sup>3</sup> /h)	260	405	545	660
Ses (dBA)	44	55	63	68





# FORMAT / FORMAT PLUS / CRYSTAL LINE

## Format



DFD 6357 XS / 600  
DFD 7357 XS / 700  
DFD 9357 XS / 900

Inox  
Inox  
Inox

110.0196.046  
110.0196.047  
110.0196.048

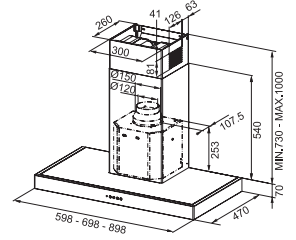

Kumanda paneli  
Aydınlatma  
Filtre  
Motor gücü  
Hız  
Boru çıkış çapı  
Ek özellikler

Soft touch düğme  
28 Watt'lık 2 halojen lambaa  
Alüminyum  
125 W  
3  
Ø150 mm / Beraberinde verilen redüksiyon Ø120 mm  
Opsiyonel karbon filtre takılabilir. (112.0016.756)

	1	2	3
Aspirasyon Debisi (m <sup>3</sup> /h)	210	285	380
Ses (dBA)	50	54	61



## Format Plus



DFDPL 905 W XS / 900

Inox

110.0378.743

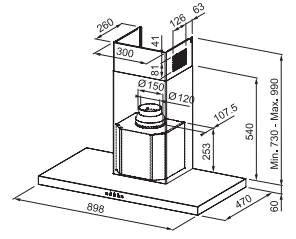

Kumanda paneli  
Aydınlatma  
Filtre  
Motor gücü  
Hız  
Boru çıkış çapı  
Ek özellikler

Soft touch düğme  
1 Watt'lık 2 led lamba  
Çelik kaset  
260 W  
3+1  
Ø150 mm / Beraberinde verilen redüksiyon Ø120 mm  
intensive speed fonksiyonu, ışık ayarı sağlayan Comfort light, 30 dakika auto stop çalıştırma programı, Opsiyonel karbon filtre takılabilir. (112.0016.75)

	1	2	3	int.
Aspirasyon Debisi (m <sup>3</sup> /h)	270	410	530	620
Ses (dBA)	45	54	60	63



## Crystal Line



FCR 903 BK / XS / 900

Black Glass  
+Inox

110.0379.173

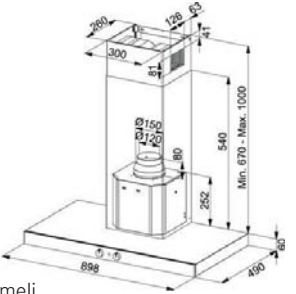

Kumanda paneli  
Aydınlatma  
Filtre  
Motor gücü  
Hız  
Boru çıkış çapı  
Ek özellikler

Crystal Line Seris yuvarlak düğmeli  
1 Watt'lık 2 led lamba  
Alüminyum  
127 W  
3  
Ø150 mm / Beraberinde verilen redüksiyon Ø120 mm  
Opsiyonel karbon filtre takılabilir. (112.0016.756)

	1	2	3
Aspirasyon Debisi (m <sup>3</sup> /h)	220	310	370
Ses (dBA)	52	56	63





FCR 625 TC BK/XS/600  
FCR 925 TC BK/XS/900  
FCR 625 TC WH/XS/600  
FCR 925 TC WH/XS/900

Black Glass / Inox 110.0361.047  
Black Glass / Inox 110.0361.046  
White Glass / Inox 110.0379.171  
White Glass / Inox 110.0379.172

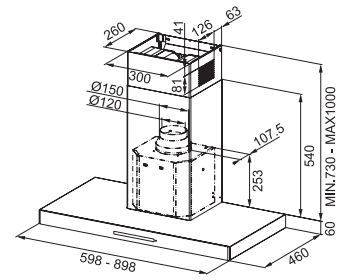

	1	2	3	int.
<b>Aspirasyon Debisi (m<sup>3</sup>/h)</b>	290	435	575	690
<b>Ses (dBA)</b>	51	60	65	69

#### Kumanda paneli

Aydınlatma

Filtre

Motor gücü

Hız

Boru çıkış çapı

Ek özellikler

Dokunmatik çok fonksiyonlu elektronik kumanda,

1 Watt'lık 2 led lamba

Çelik kaset

250 W

3+1

Ø150 mm / Beraberinde verilen redüksiyon Ø120 mm

Işık ayarı sağlayan Comfort light, intensive Speed fonksiyonu, 30 dk. auto stop çalıştırma programı, opsiyonel karbon filtre takılabilir.(112.0016.756)





	1	2	3
<b>Aspirasyon Debisi (m<sup>3</sup>/h)</b>	240	365	430
<b>Ses (dBA)</b>	51	59	65

FNE 605 XS/600  
FNE 905 XS/900

Black Glass / Inox  
Black Glass / Inox

110.0260.652  
110.0196.091

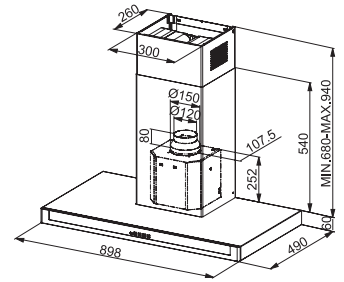

Kumanda paneli  
Aydınlatma  
Filtre  
Motor gücü  
Hız  
Boru çıkışı çapı  
Ek özellikler

Soft touch düğme  
20 Watt'lık 2 halojen lamba  
Alüminyum  
145 W  
3  
Ø150 mm / Beraberinde verilen redüksiyon Ø120 mm  
Opsiyonel karbon filtre takılabilir. (112.0016.756)





FGB 906 W AC/900

Black Glass / Inox

110.0338.359

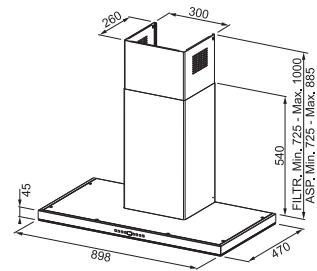

	1	2	3	4	int.
Aspirasyon Debisi (m <sup>3</sup> /h)	200	370	485	620	840
Ses (dBA)	42	53	59	65	71

Kumanda paneli  
Aydınlatma  
Filtre  
Motor gücü  
Hız  
Boru çıkış çapı  
Ek özellikler

Çok fonksiyonlu elektronik kumanda paneli  
4 Watt'lık 2 led lamba  
Çelik kaset  
270 W  
4+1  
Ø150 mm  
Intensive Speed fonksiyonu, 30 dakika auto stop çalıştırma programı, çelik kaset filtre, Brushless tasarruflu motor motor, cam yüzey çekim alanında Anti-Condensation kurutma sistemi  
Opsiyonel karbon filtre takılabilir. (112.0016.756)



#### Brushless motor

Standart motora göre %85'e varan enerji tasarrufu



#### Anti-Condensation system

Pişirme sırasında cam yüzeyinde oluşan su damlacıklarının hızlı kurumasını sağlayan özel teknoloji



FPJ 615 V BK A / 600	Black Glass	110.0361.890
FPJ 915 V BK A / 900	Black Glass	110.0361.902
FPJ 615 V WH A / 600	White Glass	110.0361.903
FPJ 915 V WH A / 900	White Glass	110.0361.907

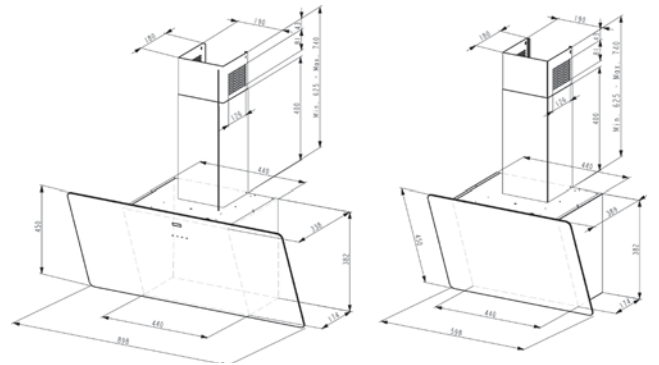

	1	2	3
Aspirasyon Debisi (m <sup>3</sup> /h)	300	430	560
Ses (dBA)	57	60	66

#### Kumanda paneli

Aydınlatma  
Filtre  
Motor gücü  
Hız  
Boru çıkış çapı  
Ek özellikler

Dokunmatik elektronik kumanda,  
1,1 Watt'lık 2 led lamba  
Çelik kaset  
148 W  
3  
Ø150 mm / Beraberinde verilen redüksiyon Ø120 mm  
Opsiyonel karbon filtre takılabilir. (112.0016.755)





FSMI 605 BK  
FSMI 905 BK  
FSMI 605 WH  
FSMI 905 WH

Black Glass  
Black Glass  
White Glass  
White Glass

330.0489.611  
330.0489.612  
330.0489.613  
330.0489.614

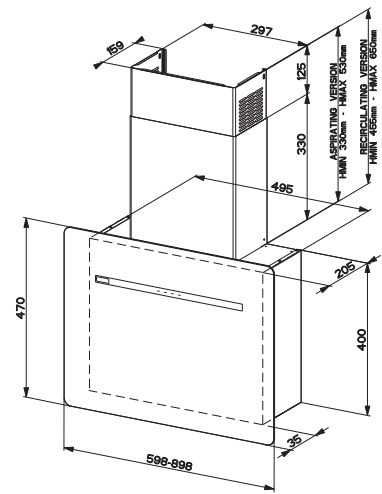

Kumanda paneli  
Aydınlatma  
Filtre  
Motor gücü  
Hız  
Boru çıkış çapı  
Ek özellikler

Dokunmatik  
3 Watt'lık 1 LED lamba  
Alüminyum  
125 W  
3+1  
Ø150 mm  
Intensive speed fonksiyonu, Opsiyonel karbon filtre takılabilir. ( 112.0493.825)  
Dekoratif baca dahildir

	1	2	3	int.
Aspirasyon Debisi (m <sup>3</sup> /h)	290	440	520	560
Ses (dBA)	57	66	70	72







FMA 605 BK/600	Black Glass	110.0437.300
FMA 905 BK/900	Black Glass	110.0437.391
FMA 605 WH/600	White Glass	110.0437.392
FMA 905 WH/900	White Glass	110.0437.393
FMA 605 BK/XS/600	Black Glass / Inox	110.0437.394
FMA 905 BK/XS/900	Black Glass / Inox	110.0437.395

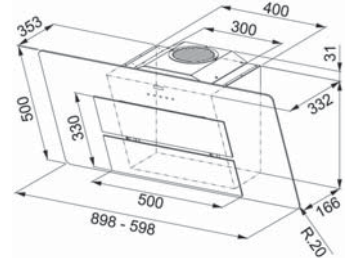

	1	2	3	int.
Aspirasyon Debisi (m <sup>3</sup> /h)	260	400	540	660
Ses (dBA)	47	56	63	66

Kumanda paneli  
Aydınlatma  
Filtre  
Motor gücü  
Hız  
Boru çıkış çapı  
Ek özellikler

Dokunmatik çok fonksiyonlu elektronik kumanda  
20 Watt'lık 2 halojen lamba  
Alüminyum  
250 W  
3+1  
Ø150 mm / Beraberinde verilen redüksiyon Ø120 mm  
Intensive speed fonksiyonu, 30 dakika auto stop  
çalıştırma programı, Hassas ışık ayarı sağlayan Comfort  
Light. Opsiyonel karbon filtre takılabilir. ( 112.0016.755)







FSN 908 BK A/900  
FSN 908 WH A/900  
Uzaktan Kumanda

Black Glass  
White Glass

110.0282.634  
110.0282.635  
112.0174.991

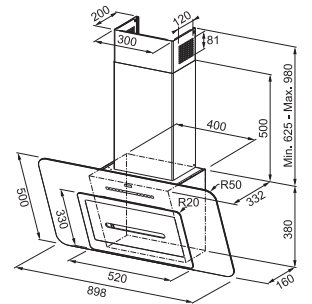

Kumanda paneli

Aydınlatma  
Filtre  
Motor gücü  
Hız  
Boru çıkış çapı  
Ek özellikler

Dokunmatik çok fonksiyonlu elektronik kumanda,  
5 Watt'lık 2 led  
Çelik kaset  
270 W  
4+1  
Ø150 mm / Beraberinde verilen redüksiyon Ø120 mm  
intensive speed fonksiyonu, mekan havasının devamlı temizliği için 24 saat boyunca belli aralıklarla davlumbazı çalıştıran 24 saat fonksiyonu, Alüminyum ve karbon filtre dolum uyarısı, timer 30 dakika auto stop çalıştırma programı, Hassas ışık ayarı sağlayan Comfort Light. Opsiyonel karbon filtre takılabilir. (112.0016.755)  
**Dekoratif baca kullanımı zorunludur.**

	1	2	3	4	int.
Aspirasyon Debisi (m <sup>3</sup> /h)	200	370	485	610	850
Ses (dBA)	42	53	59	64	70



**Brushless motor**

Standart motora göre %85'e varan enerji tasarrufu



FMY 606 BK/600	Black Glass	110.0377.746
FMY 906 BK/900	Black Glass	110.0377.742
FMY 606 WH/600	White Glass	110.0377.749
FMY 906 WH/900	White Glass	110.0377.747
Uzaktan Kumanda		112.0174.991



Kumanda paneli  
Aydınlatma  
Filtre  
Motor gücü  
Hız  
Boru çıkış çapı  
Ek özellikler

Dokunmatik çok fonksiyonlu elektronik kumanda  
1 Watt'lık 2 led lamba  
Alüminyum  
270 W  
3+1  
Ø150 mm / Beraberinde verilen redüksiyon Ø120 mm  
Intensive speed fonksiyonu, mekan havasının devamlı temizliği için 24 saat boyunca belli aralıklarla davlumbazı çalıştıran 24 saat fonksiyonu, Alüminyum ve karbon filtre dolum uyarısı, timer 30 dakika auto stop çalıştırma programı, Hassas ışık ayarı sağlayan Comfort Light. Opsiyonel karbon filtre takılabilir. (112.0016.755)  
**Dekoratif baca kullanımı zorunludur.**

112.0016.755 kodlu karbon filtre ürün ile birlikte kutu içerisinde çıkmaktadır.  
112.0197.447 kodlu baca ayrı pakette ürün ile birlikte sevk edilmektedir.



	1	2	3	int.
Aspirasyon Debisi (m <sup>3</sup> /h)	300	470	560	700
Ses (dBA)	48	56	63	68





## Maris Plus



FMPL 606 BK B/600	Black Glass / İnox	110.0338.340
FMPL 906 BK B/900	Black Glass / İnox	110.0338.357
FMPL 606 WH B/600	White Glass / İnox	110.0338.351
FMPL 906 WH B/900	White Glass / İnox	110.0338.358
Uzaktan Kumanda		112.0174.991

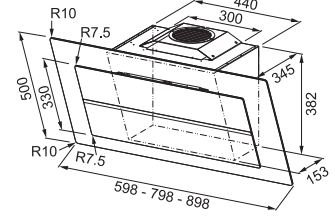

Kumanda paneli  
Aydınlatma  
Filtre  
Motor gücü  
Hız  
Boru çıkış çapı  
Ek özellikler

Gizli dokunmatik çok fonksiyonlu elektronik kumanda  
1 Watt'lık 2 led  
Alüminyum  
270 W  
3+1  
Ø150 mm / Beraberinde verilen redüksiyon Ø120 mm  
Mekan havasının devamlı temizliği için 24 saat boyunca belli aralıklarla davlumbazı çalıştıran 24 fonksiyonu, Alüminyum ve karbon filtre dolun uyarısı, Hassas ışık ayarı sağlayan Comfort light, Instensive speed fonksiyonu, Timer; 30 dakika auto stop çalıştırma programı, Filtre üzeri estetik çelik kapak, Opsiyonel karbon filtre takılabilir. (112.0016.755)

	1	2	3	int.
Aspirasyon Debisi (m <sup>3</sup> /h)	280	510	650	870
Ses (dBA)	49	58	67	73



112.0016.755 kodlu karbon filtre ürün ile birlikte kutu içerisinde çıkmaktadır.  
112.0197.447 kodlu baca ayrı pakette ürün ile birlikte sevk edilmektedir.

## Swing



FSW 918 BK XS/900	Black Glass / İnox	110.0260.660
FSW 918 WH XS/900	White Glass / İnox	110.0260.671
Uzaktan Kumanda		112.0174.991

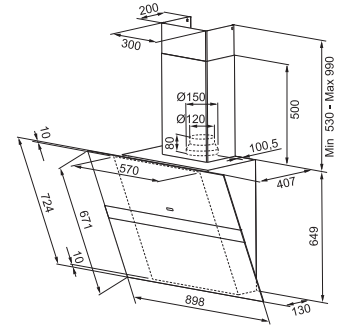

Kumanda paneli  
Aydınlatma  
Filtre  
Motor gücü  
Hız  
Boru çıkış çapı  
Ek özellikler

Dokunmatik çok fonksiyonlu elektronik kumanda  
20 Watt'lık 2 halojen lamba, ön panelde 10 Watt'lık led  
Alüminyum  
270 W  
4+1  
Ø150 mm / Beraberinde verilen redüksiyon Ø120 mm  
Mekan havasının devamlı temizliği için 24 saat boyunca belli aralıklarla davlumbazı çalıştıran 24 saat fonksiyonu, Alüminyum ve karbon filtre dolun uyarısı, Hassas ışık ayarı sağlayan Comfort light, Instensive speed fonksiyonu, Timer; 30 dakika auto stop çalıştırma programı, Filtre üzeri estetik çelik kapak, Opsiyonel karbon filtre takılabilir. (112.0016.755)

	1	2	3	4	int.
Aspirasyon Debisi (m <sup>3</sup> /h)	225	330	530	730	860
Ses (dBA)	39	54	59	68	72





**FCRV 908 XS/900**  
Uzaktan Kumanda

**Inox+Mirror Nero**

**110.0200.793**  
**112.0016.759**

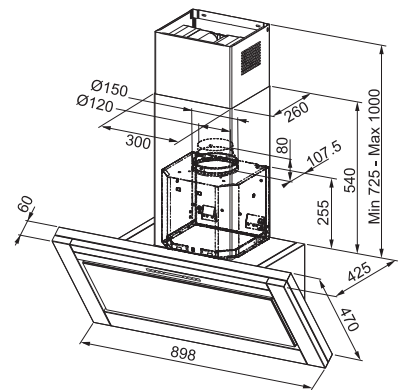

	1	2	3	int.
<b>Aspirasyon Debisi (m<sup>3</sup>/h)</b>	260	390	535	645
<b>Ses (dBA)</b>	47	56	63	66

**Kumanda paneli**  
**Aydınlatma**  
**Filtre**  
**Motor gücü**  
**Hız**  
**Boru çıkış çapı**  
**Ek özellikler**

Dokunmatik çok fonksiyonlu elektronik kumanda  
20 Watt'lık 2 halojen lamba  
Alüminyum  
250 W  
3+1  
Ø150 mm / Beraberinde verilen redüksiyon Ø120 mm  
Mekan havasının devamlı temizliği için 24 saat boyunca belli aralıklarla davlumbazı çalıştıran 24 fonksiyonu,  
Alüminyum ve karbon filtre dolum uyarısı, Hassas ışık ayarı sağlayan Comfort light, Instensive speed fonksiyonu, Timer; 30 dakika auto stop çalıştırma programı, Filtre üzeri estetik çelik kapak, Opsiyonel karbon filtre takılabilir.  
(112.0016.756)



# TUNNEL / NEPTUN KÖŞE

## Tunnel



FTU 3807 W XS 89H    Inox  
Cam Aksesuar  
Uzaktan Kumanda

110.0378.747  
112.0016.760  
112.0016.759

Kumanda paneli

Çok fonksiyonlu elektronik kumanda

Aydınlatma

1 Watt'lık 2 led lamba

Filtre

Alüminyum

Motor gücü

270 W

Hız

3+1

Boru çıkış çapı

Ø150 mm / Beraberinde verilen redüksiyon Ø120 mm

Ek özellikler

Mekan havasının devamlı temizliği için 24 saat boyunca belli aralıklarla davlumbazı çalıştıran 24 fonksiyonu, Alüminyum ve karbon filtre dolum uyarısı, Hassas ışık ayarı sağlayan Comfort light, Instensive speed fonksiyonu, Timer; 30 dakika auto stop çalıştırma programı, Opsiyonel karbon filtre takılabilir. (112.0016.756)

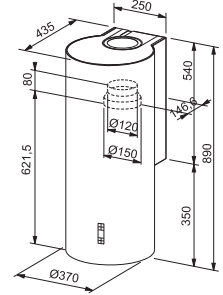

	1	2	3	int.
Aspirasyon Debisi (m <sup>3</sup> /h)	280	410	550	660
Ses (dBA)	53	60	67	70

Opsiyonel 90 cm cam.  
112.0016.760



## Neptun Köşe



FDPA 904 XS/900

Inox

110.0020.698

Kumanda paneli

Düğmeli

Aydınlatma

20 Watt'lık 4 halojen lamba

Filtre

Çelik kaset

Motor gücü

205 W

Hız

3

Boru çıkış çapı

Ø150 mm / Beraberinde verilen redüksiyon Ø120 mm

Ek özellikler

Opsiyonel karbon filtre takılabilir. (112.0016.755)

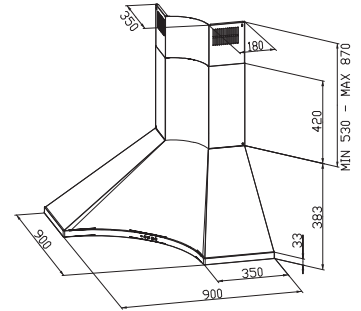

	1	2	3
Aspirasyon Debisi (m <sup>3</sup> /h)	305	445	685
Ses (dBA)	53	60	69



Sirio



FDS 654 OA/600  
FDS 954 OA/900

Avena  
Avena



110.0017.940  
110.0015.224

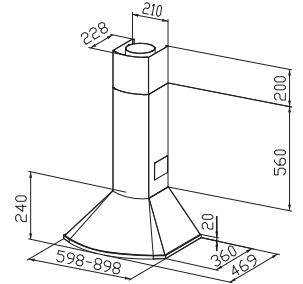

Kumanda paneli  
Aydınlatma  
Filtre  
Motor gücü  
Hız  
Boru çıkış çapı  
Ek özellikler

Düğmeli  
40 Watt'lık 2 lamba  
Alüminyum  
190 W  
3  
Ø150 mm / Beraberinde verilen redüksiyon Ø120 mm  
Opsiyonel karbon filtre takılabilir. (112.0016.755)

	1	2	3
Aspirasyon Debisi (m <sup>3</sup> /h)	260	370	480
Ses (dBA)	51	59	65



Classicline



FCM 904 PW/900  
FCM 904 GF/900

Krem  
Grafite



110.0319.360  
110.0319.371

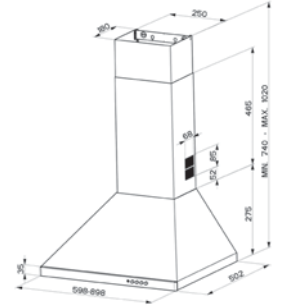

Kumanda paneli  
Aydınlatma  
Filtre  
Motor gücü  
Hız  
Boru çıkış çapı  
Ek özellikler

Düğmeli  
28 Watt'lık 2 halojen lamba  
Çelik kaset  
125 W  
3  
Ø150 mm / Beraberinde verilen redüksiyon Ø120 mm  
Altın rengi soft touch düğme, altın rengi dekoratif askı  
Opsiyonel karbon filtre takılabilir. (112.0016.755)

	1	2	3
Aspirasyon Debisi (m <sup>3</sup> /h)	260	370	480
Ses (dBA)	51	59	65



Trendline



FTL 905 XS / 900  
FTL 905 PW / 900

Inox  
Krem



110.0181.671  
110.0181.672

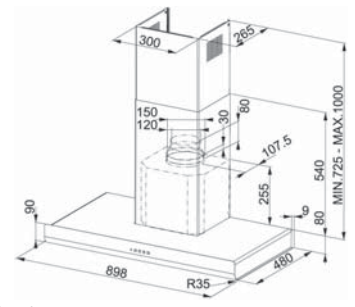

Kumanda paneli  
Aydınlatma  
Filtre  
Motor gücü  
Hız  
Boru çıkış çapı  
Ek özellikler

Soft touch düğme  
20 Watt'lık 2 halojen lamba  
Alüminyum  
140 W  
3+1  
Ø150 mm / Beraberinde verilen redüksiyon Ø120 mm  
Instensive speed fonksiyonu  
Opsiyonel karbon filtre takılabilir. (112.0016.756)

	1	2	3	int.
Aspirasyon Debisi (m <sup>3</sup> /h)	240	365	470	530
Ses (dBA)	46	56	63	66



# COUNTRY LONDRA / COUNTRY SCOTLAND / CLASSIC LORD

## Country Londra



\* FCL 602/600 (110.0017.957) çerçevesizdir. Tercih edilen renkteki ahşap çerçeve ayrıca sipariş edilmelidir.



	1	2	3
Aspirasyon Debisi (m <sup>3</sup> /h)	240	320	420
Ses (dBA)	49	54	61

FCL 602/600\*

FCL 602 ÇERÇEVE

FCL 602 ÇERÇEVE

FCL 602 ÇERÇEVE

Ceviz

Kiraz

Ham

110.0017.957

112.0018.031

112.0018.032

112.0018.034

Kumanda paneli  
Aydınlatma  
Filtre  
Motor gücü  
Hız  
Boru çıkış çapı  
Ek özellikler

Düğmeli  
40 Watt'lık 2 lamba  
Alüminyum  
150 W  
3  
Ø150 mm / Beraberinde verilen redüksiyon Ø120 mm  
Krem Rengi Gövde  
Opsiyonel karbon filtre takılabilir.(112.0016.755)

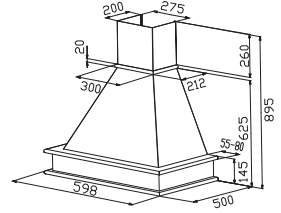

## Country Scotland



\* FCS 902/900 (110.0017.947) çerçevesizdir. Tercih edilen renkteki ahşap çerçeve ayrıca sipariş edilmelidir.



	1	2	3
Aspirasyon Debisi (m <sup>3</sup> /h)	240	320	420
Ses (dBA)	49	54	61

FCS 902/900\*

FCS 902 ÇERÇEVE

FCS 902 ÇERÇEVE

FCS 902 ÇERÇEVE

Ceviz

Kiraz

Ham

110.0017.947

112.0018.023

112.0018.024

112.0018.026

Kumanda paneli  
Aydınlatma  
Filtre  
Motor gücü  
Hız  
Boru çıkış çapı  
Ek özellikler

Düğmeli  
40 Watt'lık 2 lamba  
Alüminyum  
150 W  
3  
Ø150 mm / Beraberinde verilen redüksiyon Ø120 mm  
Krem Rengi Gövde  
Opsiyonel karbon filtre takılabilir.(112.0016.755)

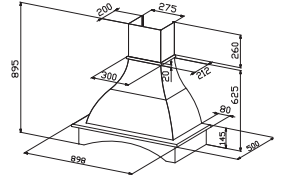

## Classic Lord



\* FCL 912/900 (110.0017.952) çerçevesizdir. Tercih edilen renkteki ahşap çerçeve ayrıca sipariş edilmelidir.



	1	2	3
Aspirasyon Debisi (m <sup>3</sup> /h)	240	320	420
Ses (dBA)	49	54	61

FCL 912/900\*

FCL 912 ÇERÇEVE

FCL 912 ÇERÇEVE

FCL 912 ÇERÇEVE

Ceviz

Kiraz

Ham

110.0017.952

112.0018.027

112.0018.028

112.0018.030

Kumanda paneli  
Aydınlatma  
Filtre  
Motor gücü  
Hız  
Boru çıkış çapı  
Ek özellikler

Düğmeli  
28 Watt'lık 2 lamba  
Alüminyum  
135 W  
3  
Ø150 mm / Beraberinde verilen redüksiyon Ø120 mm  
Krem Rengi Gövde  
Opsiyonel karbon filtre takılabilir.(112.0016.757)

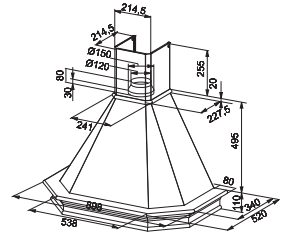

## Classic Lord



	1	2	3
Aspirasyon Debisi (m <sup>3</sup> /h)	305	445	685
Ses (dBA)	53	60	69

FCL 924 CO/900

Bakır

110.0017.967

Kumanda paneli  
Aydınlatma  
Filtre  
Motor gücü  
Hız  
Boru çıkış çapı  
Ek özellikler

Düğmeli  
40 watt'lık 2 lamba  
Alüminyum  
205 W  
3  
Ø150 mm / Beraberinde verilen redüksiyon Ø120 mm  
Opsiyonel karbon filtre takılabilir.(112.0016.755)

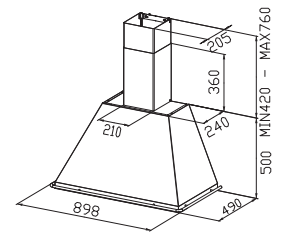





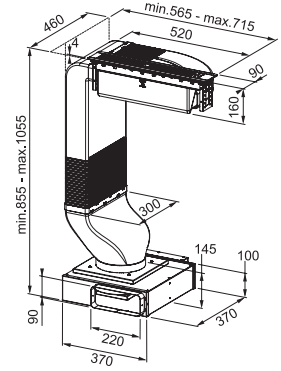

Kumanda paneli  
Filtre  
Motor gücü  
Hız  
Boru çıkış çapı  
Ek özellikler

Dokunmatik  
Alüminyum  
145 W  
3+1  
Ø150 mm / Beraberinde verilen redüksiyon Ø120 mm  
Intensive speed fonksiyonu, Timer; 30 dakika auto stop  
çalıştırma programı.  
\*Görselde bulunan cam kapak ve metal ızgara ürüne  
dahildir. İsteğe göre uygun olan şekilde kullanılabilir.  
Opsiyonel karbon filtre takılabilir. (112.0470.632)

A+



	1	2	3	int.
Aspirasyon Debisi (m <sup>3</sup> /h)	400	450	500	560
Ses (dBA)	62	64	67	70

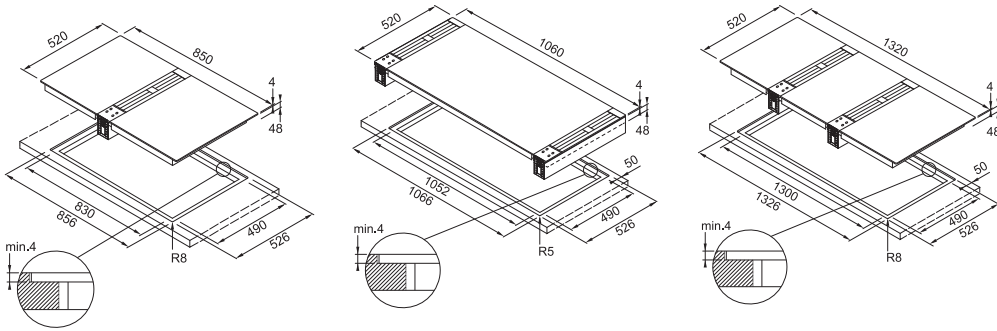

MYTHOS OCAK İLE TEZGAH  
ÜZERİNDE KUSURSUZ BİRLEŞİM



Yan resimdeki konfigürasyon davlumbaz ve 2 adet 108.0391.248 kodlu ocaktan oluşmaktadır. Ocaklar ve davlumbazın ayrı sipariş edilmesi gerekir.



FDW 908 IB XS  
FDW 908 IB XS

Black Glass / Inox  
White Glass / Inox

110.0365.588  
110.0368.794

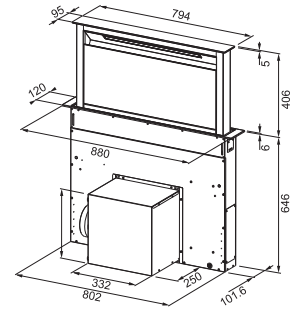
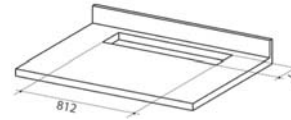

Destek düzlemi delindikten sonra, davlumbaz gövdesine iki şekilde monte edilebilir.  
• Yukarıdan davlumbaz gövdesinin içine takarak (X = 113 mm)

**Kumanda paneli**  
**Aydınlatma**  
**Filtre**  
**Motor gücü**  
**Hız**  
**Boru çıkış çapı**  
**Ek özellikler**

Dokunmatik çok fonksiyonlu elektronik kumanda  
10 Watt'lık 1 led aydınlatma  
Filtre üzeri estetik çelik kapak  
275 W  
4+1  
Ø150 mm  
Alüminyum ve karbon filtre dolum uyarısı, Işık ayarı sağlayan  
Comfort light, Intensive speed fonksiyonu, Timer; 30 dakika  
auto stop çalıştırma programı  
112.0174.991 kodlu uzaktan kumanda ayrı pakette ürün ile birlikte  
sevk edilmektedir.  
112.0261.258 kodlu karbon filtre ürün ile birlikte sevk edilmektedir.

	1	2	3	4	int.
<b>Aspirasyon Debisi (m<sup>3</sup>/h)</b>	160	290	380	420	670
<b>Ses (dBA)</b>	38	46	51	57	69



## Ada Glass Linear



FGL 915 I XS/900

Glass / Inox

110.0152.543

FGL 915 I BK XS/900

Black Glass / Inox

110.0301.324

	1	2	3	int.
Aspirasyon Debisi (m <sup>3</sup> /h)	260	405	545	660
Ses (dBA)	45	56	63	68



Kumanda paneli  
Aydınlatma  
Filtre  
Motor gücü  
Hız  
Boru çıkış çapı  
Ek özellikler

Soft touch düğme  
20 Watt'lık 4 halojen lamba  
Çelik kaset  
250 W  
3+1  
Ø150 mm / Beraberinde verilen redüksiyon Ø120 mm  
İntensive speed fonksiyonu,  
Opsiyonel karbon filtre takılabilir. (112.0016.756)

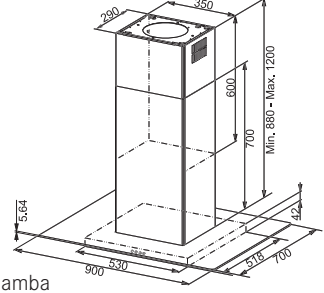

## Ada Glass Soft



FGC 906 I XS/900

Inox

110.0016.635

	1	2	3	int.
Aspirasyon Debisi (m <sup>3</sup> /h)	260	405	545	660
Ses (dBA)	45	56	63	68



Kumanda paneli  
Aydınlatma  
Filtre  
Motor gücü  
Hız  
Boru çıkış çapı  
Ek özellikler

Çok fonksiyonlu elektronik kumanda  
20 watt'lık 4 halojen lamba  
Çelik kaset  
205 W  
3+1  
Ø150 mm / Beraberinde verilen redüksiyon Ø120 mm  
İntensive speed fonksiyonu  
Timer; 30 dakika auto stop çalıştırma programı  
Opsiyonel karbon filtre takılabilir. (112.0016.756)

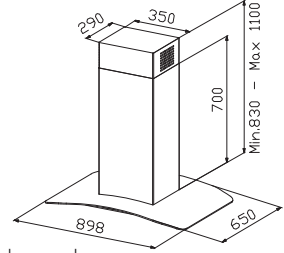

## Ada Tunnel



Opsiyonel 90 cm ada cam.  
112.0016.761

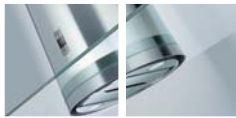

	1	2	3	int.
Aspirasyon Debisi (m <sup>3</sup> /h)	280	510	670	660
Ses (dBA)	52	60	65	68

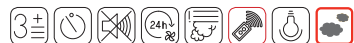

Kumanda paneli  
Aydınlatma  
Filtre  
Motor gücü  
Hız  
Boru çıkış çapı  
Ek özellikler

Çok fonksiyonlu elektronik kumanda  
1 watt'lık 2 led lamba (4000 K)  
Alüminyum  
270 W  
3+1  
Ø150 mm / Beraberinde verilen redüksiyon Ø120 mm  
Mekan havasının devamlı temizliği için 24 saat boyunca belli aralıklarla davlumbazı çalıştıran 24 fonksiyonu,  
Alüminyum ve karbon filtre dolum uyarısı, Hassas ışık ayarı sağlayan Comfort light, İntensive speed fonksiyonu,  
Timer; 30 dakika auto stop çalıştırma programı  
Opsiyonel karbon filtre takılabilir. (112.0016.756)

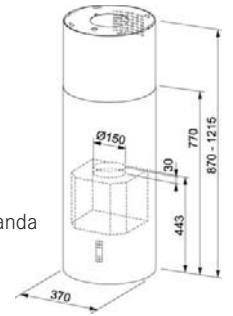

## Ada Format 45/900



FDF 9354 I XS/900

Inox

110.0196.073

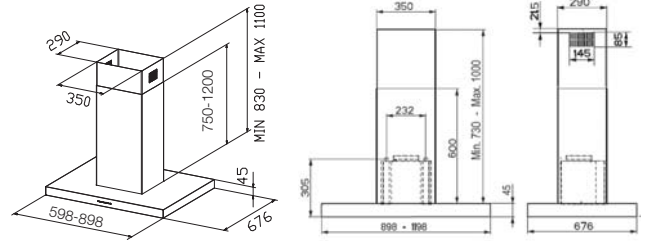

Kumanda paneli  
Aydınlatma  
Filtre  
Motor gücü  
Hız  
Boru çıkış çapı  
Ek özellikler

Soft touch düğme  
20 Watt'lık 4 halojen lamba  
Çelik kaset  
250 W  
3+1  
Ø150 mm / Beraberinde verilen redüksiyon Ø120 mm  
30 dakika auto stop çalıştırma programı, intensive speed fonksiyonu, Hassas ışık ayarı sağlayan Comfort light  
Opsiyonel karbon filtre takılabilir. (112.0016.756)

	1	2	3	int.
Aspirasyon Debisi (m <sup>3</sup> /h)	260	405	545	660
Ses (dBA)	45	56	63	68



## Ada Format 45/1200



FDF 12274 I XS/1200

Inox

110.0275.411

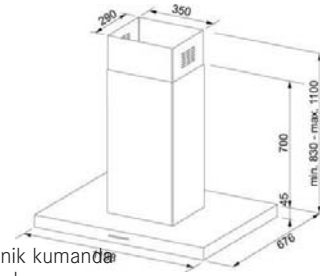

Kumanda paneli  
Aydınlatma  
Filtre  
Motor gücü  
Hız  
Boru çıkış çapı  
Ek özellikler

Çok fonksiyonlu elektronik kumanda  
20 Watt'lık 4 halojen lamba  
Çelik kaset  
275 W  
3+1  
Ø150 mm / Beraberinde verilen redüksiyon Ø120 mm  
Mekan havasının devamlı temizliği için 24 saat boyunca belli aralıklarla davlumbazı çalıştıran 24 fonksiyonu, 30 dakika auto stop çalıştırma programı, intensive speed fonksiyonu, Işık ayarı sağlayan Comfort light  
Opsiyonel karbon filtre takılabilir. (112.0016.756)

	1	2	3	int.
Aspirasyon Debisi (m <sup>3</sup> /h)	365	560	690	750
Ses (dBA)	55	64	69	70



## Ada Format Plus



FDFPL 905 P I XS / 900

Inox

110.0378.744

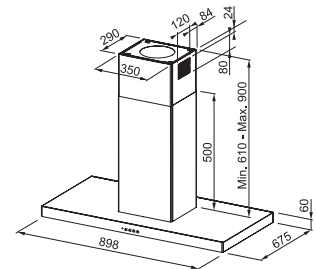

Kumanda paneli  
Aydınlatma  
Filtre  
Motor gücü  
Hız  
Boru çıkış çapı  
Ek özellikler

Soft touch düğme  
1 Watt'lık 4 led lamba  
Çelik kaset, filtre üzeri estetik çelik kapak  
272 W  
3+1  
Ø150 mm / Beraberinde verilen redüksiyon Ø120 mm  
30 dakika auto stop çalıştırma programı, intensive speed fonksiyonu, Comfort light  
Opsiyonel karbon filtre takılabilir. (112.0016.756)

	1	2	3	int.
Aspirasyon Debisi (m <sup>3</sup> /h)	270	410	530	620
Ses (dBA)	45	54	60	63







FCBI 1204 C WH B RF / 1200 White Glass

110.0338.397

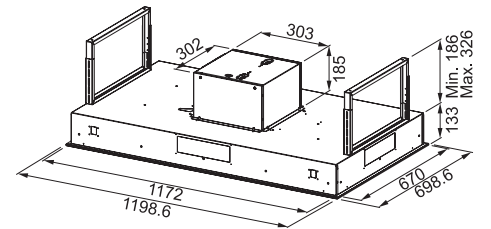
**Brushless motor**

Standart motora göre %85'e varan enerji tasarrufu

**Radyofrekans uzaktan kumanda**

**Kumanda paneli**  
**Aydınlatma**  
**Filtre**  
**Motor gücü**  
**Hız**  
**Boru çıkış çapı**  
**Ek özellikler**

Elektronik

4 Watt'lık 2 led

Çelik kaset, filtre üzeri estetik çelik kapak

270 W

4+1

Ø150 mm

120 cm. Ankastre, timer 30 dakika auto stop özelliği, intensive speed fonksiyonu, Filtre üzeri estetik cam kapak, Filtre dolum uyarısı.

Ocak ile davlumbaz arası montaj mesafesi min.650 mm. - max. 1500 mm

Tavan - zemin mesafesi max. 2600 mm. ye kadar olan mutfaklarda kullanılabilir, Radyofrekans uzaktan kumanda dahildir.

Opsiyonel karbon filtre (112.0174.995)

	1	2	3	int.
<b>Aspirasyon D.(m<sup>3</sup>/h)</b>	240	400	640	860
<b>Ses (dBA)</b>	42	53	67	73





FUD 5007 I XS/520

Inox

110.0159.378

FUDL APOLLO

Inox

112.0166.617

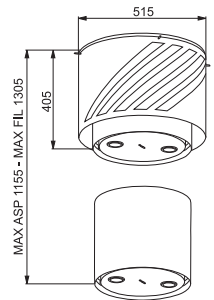

Kumanda paneli  
Aydınlatma  
Filtre  
Motor gücü  
Hız  
Boru çıkış çapı  
Ek özellikler

Çok fonksiyonlu elektronik kumanda  
4 Watt'lık 2 halojen lamba

Alüminyum

250 W

3+1

Ø150 mm

Mekan havasının devamlı temizliği için 24 saat boyunca belli aralıklarla davlumbazı çalıştıran 24 fonksiyonu, timer 30 dk. auto stop özelliği, intensive speed fonksiyonu, filtre üzeri estetik çelik kapak

Apollo davlumbaz için iki kod birlikte sipariş verilmelidir.

2 adet elektrik hattı çekilmeli, aydınlatma ünitesi için elektrik anahtarı konulmalıdır.

Yüksek performanslı karbon filtre dahildir. (112.0174.995)

112.0016.759 kodlu uzaktan kumanda ürün ile birlikte kutu içerisinden çıkmaktadır

	1	2	3	int.
Aspirasyon Debisi (m <sup>3</sup> /h)	230	355	450	520
Ses (dBA)	49	60	65	68







FME 407 XS  
FME 407 BK

Inox  
Mat Black

110.0260.618  
110.0260.619

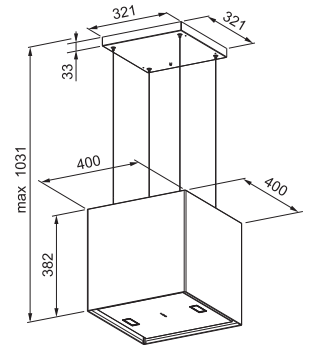

Kumanda paneli  
Aydınlatma  
Filtre  
Motor gücü  
Hız  
Boru çıkış çapı  
Ek özellikler

Çok fonksiyonlu elektronik kumanda  
5 Watt'lık 2 led lamba  
Alüminyum  
250 W  
3+1

Ø150 mm  
Mekan havasının devamlı temizliği için 24 saat boyunca belli aralıklarla davlumbazı çalıştıran 24 fonksiyonu, Timer 30 dk. auto stop özelliği, intensive speed fonksiyonu, Filtre üzeri estetik çelik kapak,  
**112.0174.991 kodlu uzaktan kumanda ürüne dahildir**  
Opsiyonel karbon filtre. (112.0174.995)

	1	2	3	int.
Aspirasyon Debisi (m <sup>3</sup> /h)	220	360	420	450
Ses (dBA)	60	67	73	75





FGB 906 IS AC/900

Inox

110.0338.388

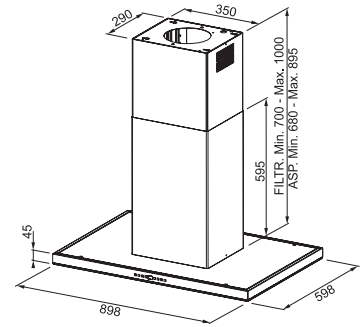

Kumanda paneli  
Aydınlatma  
Filtre  
Motor gücü  
Hız  
Boru çıkış çapı  
Ek özellikler

Çok fonksiyonlu elektronik kumanda

4 Watt'lık 2 led lamba

Çelik kaset

290 W

4+1

Ø150 mm

Intensive Speed fonksiyonu, 30 dakika auto stop çalıştırma programı

Opsiyonel karbon filtre takılabilir (112.0016.756)

	1	2	3	4	int.
Aspirasyon Debisi (m <sup>3</sup> /h)	200	370	485	620	840
Ses (dBA)	42	53	59	65	71

**Brushless motor**

Standart motora göre %85'e varan enerji tasarrufu

**Anti-Condensation system**

Pişirme sırasında cam yüzeyinde oluşan su damlacıklarının hızlı kurumasını sağlayan özel teknoloji

# YIKAMA GRUBU

Make  
it  
Wonderful



# FRANKE BULAŞIK MAKİNENİ SEÇ

Franke bulaşık makineleri ürün kalitesi, estetik ve yüksek performans özelliklerini enerji tasarrufu ihtiyaçları ile kusursuz şekilde birleştirir.

## ■ Ekonomik kullanım

A+ ve A+++ enerji sınıfı ürünler, geniş yıkama programı seçenekleri sayesinde, kullanımda ergonomi ve maksimum işlevselliği garanti eder.

## ■ Yıkama erteleme özelliği

Modele göre Franke bulaşık makinelerinde bulunan bu özellik sayesinde yıkama 3-6-9 yada 1-24 saat arasında ertelenebilir ve bu sayede hem enerji tasarrufu sağlar hem de günlük işlere göre yıkamalar programlanabilir.

## ■ İhtiyaca özel yıkama programları

6 ile 10 arası yıkama programına sahip tüm Franke bulaşık makinelerinde farklı kaplara ve kirlilik oranına göre yıkama seçenekleri bulunur.

## ■ Yüksekliği değişebilir üst sepetler

Bardak, tabak ve yüksek hacimli olan tüm kapları üst sepete sığdırmayı sağlayan hareketli sepetleri kontrol etmek için makinelerin yan tarafında bulunan klipslere basmak yeterlidir.



## ■ Çatal bıçak setleri ve küçük bulaşıklar

Çatal bıçak setlerini ayrı ayrı ve daha hijyenik dizmeyi sağlayan üst sepetler sayesinde bulaşık makinelerinin alt sepetlerinde tencere, tava gibi büyük kapların yerleşimi oldukça kolaydır.



# FRANKE ÇAMAŞIR MAKİNENİ SEÇ

Banyolar dışında mutfakda da kullanıma imkan sağlayan ankastre çamaşır makineleri yanında geniş yıkama kapasitesi sunan solo çamaşır makineleri, sahip olduğu özel yıkama programları ile üst düzeyde performans sağlıyor.



## ■ Enerji tasarrufu

A, A+ enerji sınıfına sahip ankastre ve solo çamaşır makineleri, ekonomik kullanım sağlar. Makinelerin sahip olduğu hızlı programlar sayesinde ise hem zamandan hem de enerjiden tasarruf sağlanır.

## ■ Yıkama kapasitesi

Çamaşırların yıkama sürelerini optimize etmek için 9 kg'ye kadar doldurma kapasitesine sahip paslanmaz çelik kazanlar.



## ■ Geniş yıkama programları seçenekleri

Franke çamaşır makineleri, tüm çamaşır ihtiyaçlarına yanıt vermek ve daha kısa sürede en iyi sonuçları elde etmek için 15'e varan yıkama program seçeneğine sahiptir.





FRANKE



# YIKAMA GRUBU

YARI ANKASTRE BULAŞIK MAKİNELERİ	240
TAM ANKASTRE BULAŞIK MAKİNESİ	241
ANKASTRE ÇAMAŞIR MAKİNELERİ	242
SOLO ÇAMAŞIR MAKİNELERİ	243







# TAM ANKASTRE - 60 CM / 45 CM

**FDW 612 E6P A++**  
**Çelik Kapak**

**117.0266.492**  
**112.0037.279**

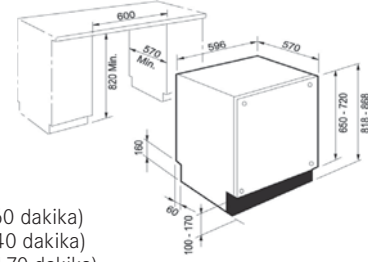

**Enerji sınıfı**  
**Ebat**  
**Program sayısı**  
**Program özellikleri**

A++  
600 mm  
6  
1 saatlik program 60° (60 dakika)  
Hızlı yıkama 40° (40 dakika)  
Eko yıkama 50° (170 dakika)  
Normal yıkama 55° (160 dakika)  
Yoğun yıkama 65° (135 dakika)

**Yıkama kapasitesi**  
**Ek özellikler**

12 set  
Hafif kirli yıkama 40° (115 dakika)  
Parlatıcı ve tuz göstergeleri, yıkama bittiğinde uyarı sinyali verme özelliği, yarım yük yıkama özelliği, program erişim kilidi, alt rafta bağımsız kaşıklık sepeti, Aquastop özelliği, kolay temizlenen özel filtre sistemi, taşma önleme sistemi, sızdırma önleme sistemi  
Yıkama A, Kurutma A

**Ses düzeyi**

49 dB



**FDW 613 DTS A+++**  
**Çelik Kapak**

**117.0250.905**  
**112.0037.279**

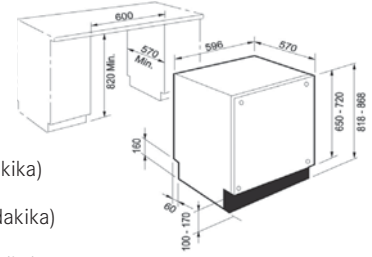

**Enerji sınıfı**  
**Ebat**  
**Program sayısı**  
**Program özellikleri**

A+++  
600 mm  
9  
Ön yıkama (15 dakika)  
Hassas 45°C yıkama (75 dakika)  
Bio 50°C yıkama  
Bio - Hızlı 60°C yıkama (70 dakika)  
Auto yıkama  
Normal 70°C yıkama (75 dakika)  
Antibakteriyel 70°C yıkama (150 dakika)  
Anti bakteriyel hızlı 70°C yıkama (135 dakika)

**Yıkama kapasitesi**  
**Ek özellikler**

13 set  
Hassas hızlı 50°C yıkama (60 dakika)  
1-24 saat ertelenebilir yıkama, parlatıcı ve tuz göstergeleri, yıkama bittiğinde uyarı sinyali verme özelliği, üçü bir arada opsiyonu, program erişim kilidi, alt rafta bağımsız kaşıklık sepeti, yüksekliği değişebilir üst sepet, Aquastop özelliği, kolay temizlenen özel filtre sistemi, taşma önleme sistemi, sızdırma önleme sistemi  
Yıkama A, Kurutma A

**Ses düzeyi**

44 dB



## 45 cm Bulaşık Makinesi

**FDW 410 E 8P A+**

**117.0282.453**

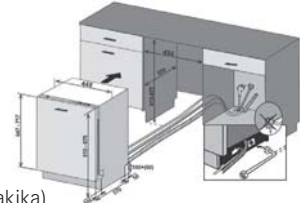

**Enerji sınıfı**  
**Ebat**  
**Program sayısı**  
**Program özellikleri**

A+  
450 mm  
10  
Ön yıkama (15 dakika)  
Az kirli, hassas 45-70 °C (65 dakika)  
Hassas 45-70 °C (65 dakika)  
Normal 65-70 °C (105 dakika)  
Bio 50-66 °C  
Yarım yük 65-70 °C (95 dakika)  
Hızlı 38-50 °C (27 dakika)  
Güçlü 70 °C (95 dakika)

**Yıkama kapasitesi**  
**Ek özellikler**

10 set  
Güçlü ve Hızlı 65-70 °C (55 dakika)  
Parlatıcı ve tuz göstergeleri, yıkama bittiğinde uyarı sinyali verme özelliği, program erişim kilidi, alt rafta bağımsız kaşıklık sepeti, yüksekliği değişebilir üst sepet, alt sepette katlanabilir tabak gözleri, su sertliği ayarlama göstergesi, üçü bir arada opsiyonu, Aquastop özelliği, kolay temizlenen özel filtre sistemi, taşma önleme sistemi, sızdırma önleme sistemi  
Yıkama A, Kurutma A

**Ses düzeyi**

46 dB



# ANKASTRE ÇAMAŞIR MAKİNELERİ

## Ankastre Çamaşır Makinesi

FWM 1400-7 EI

138.0178.424

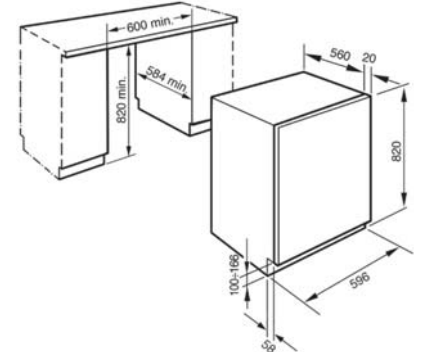

**Enerji sınıfı**  
**Ebat**  
**Program sayısı**  
**Yıkama Kapasitesi**  
**Tüketim**  
**Program özellikleri**

A+  
596 x 560 x 820  
6  
7 kg.  
46 litre su - 1.02 kW enerji tüketimi  
Dakikada 1400 devir, elektronik timer  
Aqua stop sistemi, kumanda paneli üzerinden başlatma, durdurma, ön yıkama, 6 farklı devir seçimi, soğuk durulama, ertelenmiş başlatma, kolay ütülme seçim alternatifleri, farklı ısılarla ulaşılan 15 ayrı yıkama seçeneği, özel yünlü program, hızlı yıkama programı, dijital ekran üzerinden kalan süre, alarm, erteleme göstergesi, soğuk su girişi, değişebilir kapı yönü, çocuk kilidi  
Yıkama A, Sıkma B

## Ankastre Kurutmalı Çamaşır Makinesi

FWD 1400-7 EI 3A

138.0178.425

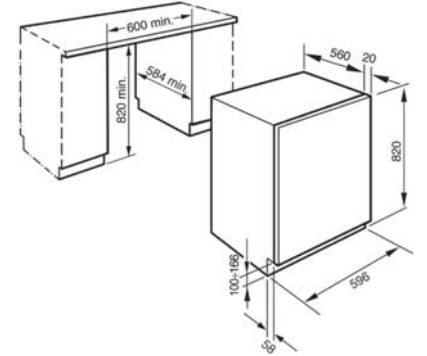

**Enerji sınıfı**  
**Ebat**  
**Program sayısı**  
**Yıkama Kapasitesi**  
**Tüketim**  
**Kurutma Kapasitesi**  
**Program özellikleri**

A  
596 x 560 x 820  
6  
7 kg.  
84 litre su - 1.02 kW enerji tüketimi  
4 kg.  
Dakikada 1400 devir, elektronik timer, kumanda paneli üzerinden başlatma, durdurma, 6 farklı devir seçimi, ön yıkama, soğuk durulama, ertelenmiş başlatma, kolay ütülme, kurutma zamanı seçim alternatifleri, farklı ısılarla ulaşılan 15 ayrı yıkama seçeneği, özel yünlü program, dijital ekran üzerinden kalan süre, alarm, kurutma zamanı ve erteleme göstergesi, soğuk su girişi, değişebilir kapı yönü,  
Yıkama A, Sıkma A

# SOLO ÇAMAŞIR MAKİNELERİ

FWMF 1006 E SIL

Gümüş

138.0264.501



**Enerji sınıfı**  
**Ebat**  
**Program sayısı**  
**Yıkama Kapasitesi**  
**Program özellikleri**

A+  
596 x 540 x 850 mm  
23  
6 kg.  
Dakikada 1000 devir, 30 dakikada hızlı yıkama programı, kolay ütüleme seçim alternatifi, ön yıkama, özel yünlü programı, özel bebek kıyafeti hassas programı, özel spor kıyafet yıkama programı, narin yıkama programı, sentetik yıkama seçeneği, dengesiz yükleme kontrolü, taşma emniyet sistemi, hız ayar (spin alternatifi), çocuk kilidi

FWMF 1209 D SIL

Gümüş

138.0264.502



**Enerji sınıfı**  
**Ebat**  
**Program sayısı**  
**Yıkama Kapasitesi**  
**Program özellikleri**

A+  
597 x 582 x 845 mm  
15  
9 kg.  
Dakikada 1200 devir, 15 dakika hızlı yıkama programı, kolay ütüleme seçim alternatifi, ön yıkama, özel yünlü programı, özel bebek kıyafeti hassas programı, özel spor kıyafet yıkama programı, narin yıkama programı, sentetik yıkama seçeneği, dengesiz yükleme kontrolü, taşma emniyet sistemi, hız ayar (spin alternatifi), çocuk kilidi, sıcaklık ayar düğmesi, LCD ekran, 33 cm. geniş kapı, ertelenmiş başlatma, farklı sıcaklıklarda, 51 farklı yıkama seçeneğine ulaşılır.

**Kurutmalı Solo Çamaşır Makinesi**

FWDF 1200-7-5 WH

Beyaz

138.0335.681



**Enerji sınıfı**  
**Ebat**  
**Program sayısı**  
**Yıkama Kapasitesi**  
**Kurutma Kapasitesi**  
**Program özellikleri**

B  
597 x 582 x 845 mm  
15  
7 kg.  
5 kg.  
Dakikada 1200 devir, taşma emniyet sistemi, 7 segmentli led ekran erteleme göstergesi, hızlı yıkama ve kurutma programı, özel yünlü programı, narin yıkama programı, sentetik yıkama seçeneği, ayarlanabilir hız (spin seçeneği), 33 cm geniş kapı  
Yıkama :A Sıkma :B





# BUZDOLAPLARI

ANKASTRE BUZDOLAPLARI	248-249
SOLO BUZDOLAPLARI	250
SOLO SIDE BY SIDE BUZDOLAPLARI	251

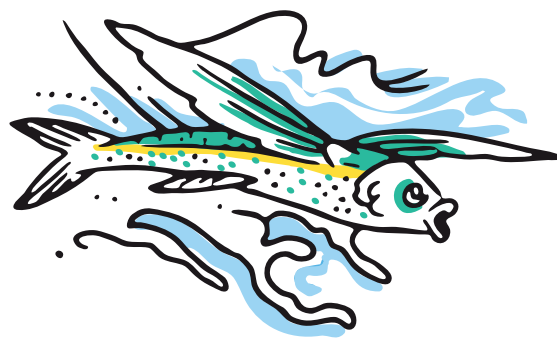

# FRANKE BUZDOLABINI SEÇ

Enerji tasarrufu sağlayan ve sessiz çalışma özelliği ile huzurlu mutfaklar yaratan ankastre buzdolapları,

Mutfak içinde gerçek bir dekorasyon ögesi olan Franke Solo buzdolapları malzemelerin kusursuzluğu, ayrıntıların inceliği ve yüksek performans düzeyleri ile dikkat çeker.



## ■ No Frost teknolojisi

Buzlanmayı engellemek üzere yiyeceklerde bulunan nemli havayı döngüsel olarak filtreleyen soğutma sistemi yiyecekleri daha uzun süre saklar, dondurulsalar bile doğal renklerini korur. Buzlanmanın uzaklaştırılması için derin dondurucu bölmesindeki buzun düzenli aralıklarla çözülmesi de önlenir.



## ■ Asılı şişe tutucu

Buzdolabına şişelerin koyulmasına olanak sağlayan ek bir alan.



## ■ Aydınlatma

Ankastre buzdolapların bulunan aydınlatma sistemi, enerji tasarrufu sağlayarak ürünün etkinliğini belirgin şekilde artırmaktadır. Daha az baskın ve daha hoş bir aydınlatma sistemi estetik görünümüne katkıda bulunur.



## ■ Cam raflar

Geniş, şık, dayanıklı ve temizlenmesi kolay cam raflar yiyeceklerin güvenle yeniden sunulması için idealdir.

## ■ Fresh Holder Bölmesi

Meyve ve sebze gibi hassas yiyeceklerin saklanması için özel olarak tasarlanan geniş bir bölme. 0° sıcaklık elektronik olarak kontrol edilir ve yiyeceklerin renklerinin, lezzetlerinin, kokularının daha uzun süre korunmasına izin verir.





## ■ Geniş iç hacim

Ankastre ve solo olmak üzere tüm Franke buzdolapları geniş iç hacme sahiptir. Uygun raf aralıkları ve yine yüksek kapasiteli derin dondurucuları sayesinde kalabalık aileler için de idealdir.



# ANKASTRE BUZDOLAPLARI



FCB 320/M SI A+ T

118.0279.889

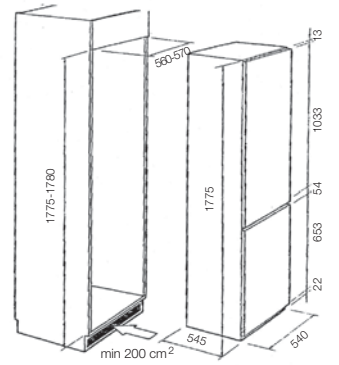

**Enerji sınıfı**  
**Ebat**  
**Derin dondurucu kapasitesi**  
**Soğutucu kapasitesi**  
**Net iç hacim**

A+  
540 x 545 x 1775 mm  
65 lt.  
203 lt.  
268 lt.

**Özellikler**

Anti bakteri özelliği  
%100 FCKW ve FKW gazlarından arındırılmış  
4 yıldızlı derin dondurucu  
Yüksekliği değişebilir 4 iç raf  
3 kapak rafı  
24 saatte 9 kg dondurma kapasitesi  
Elektrik kesintisi halinde 15 saat koruma  
Güçlü aydınlatma  
Sessiz çalışma  
Değişebilir kapı yönü  
Aksesuar yumurtalık



FSD 330/M AI A+

118.0279.992

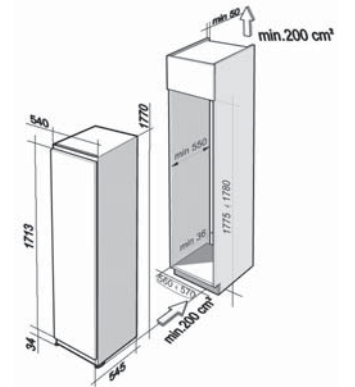

**Enerji sınıfı**  
**Ebat**  
**Net iç hacim**

A+  
540 x 545 x 1775 mm  
325 lt.

**Özellikler**

Şeffaf renkli raf ve çekmeceler  
Anti bakteri özelliği  
%100 FCKW ve FKW gazlarından arındırılmış  
6 cam raf,  
6 kapak rafı  
Güçlü aydınlatma  
Sessiz çalışma  
Değişebilir kapı yönü  
Aksesuar; yumurtalık





**FSD 340 AI A+**

**118.0183.485**

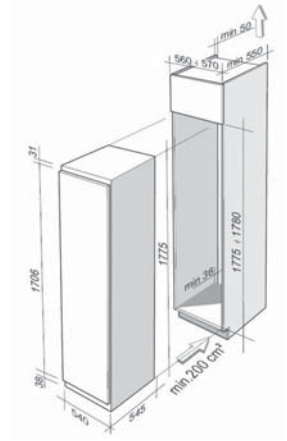

**Enerji sınıfı**  
**Ebat**  
**Derin dondurucu kapasitesi**  
**Soğutucu kapasitesi**  
**Net iç hacim**

A+  
540 x 545 x 1775 mm  
39 lt.  
253 lt.  
292 lt.

**Özellikler**

Antibakteri özelliği  
%100 FCKW ve FKW gazlarından arındırılmış  
4 yıldızlı derin dondurucu  
Yüksekliği değişebilir 4 adet cam raf  
6 adet kapak rafı  
Elektrik kesintisi halinde 14 saat koruma  
24 saatte 4 kg dondurma kapasitesi  
Güçlü aydınlatma, Sessiz çalışma  
Değişebilir kapı yönü  
Aksesuar yumurtalık



**FCB 320/D ANFI A+**

**118.0181.406**

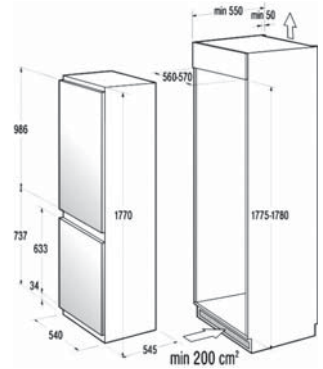

**Enerji sınıfı**  
**Ebat**  
**Derin dondurucu kapasitesi**  
**Soğutucu kapasitesi**  
**Net iç hacim**

A+  
540 x 545 x 1775 mm  
59 lt.  
203 lt.  
262 lt.

**Özellikler**

**Dondurucu kısmında No-Frost özelliği**  
Yüksekliği değişebilir 4 adet cam raf  
3 adet kapak rafı  
24 saatte 7.5 kg dondurma kapasitesi  
Elektrik kesintisi halinde 13 saat koruma  
Güçlü aydınlatma  
Sessiz çalışma  
Değişebilir kapı yönü  
Aksesuar yumurtalık

# SOLO BUZDOLAPLARI

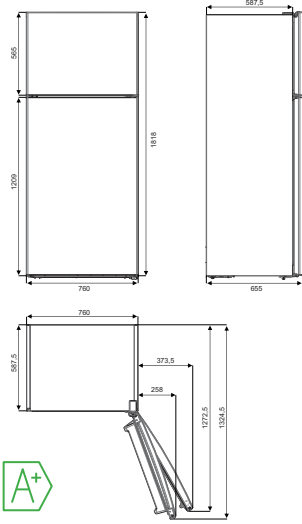

FCT 480 NF XS A+

Inox

118.0187.219



Enerji sınıfı  
Ebat

A+  
760x665x1818 mm  
(Kapı dahil, kulp hariç ölçüdür)

Derin dondurucu kapasitesi  
Soğutucu kapasitesi  
Net iç hacim

107 lt.  
362 lt.  
469 lt.

Özellikler

**Full No frost özelliği**  
24 saatte 5.5 kg dondurma kapasitesi  
Güçlü aydınlatma  
Hızlı dondurma bölgesi

Ürününüzün nakliyesi müşterimizin evine, tarafımızdan bedelsiz olarak sağlanmaktadır.

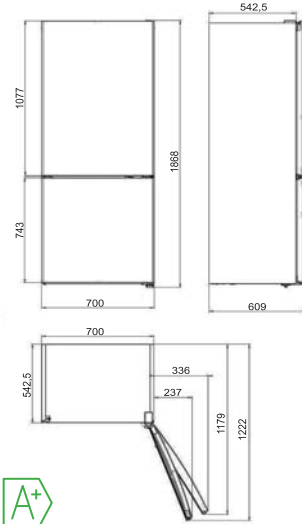

FCB 390-70 NF A+ XS

Inox

118.0192.763



Enerji sınıfı  
Ebat

A+  
700x620x1868 mm  
(Kapı dahil, kulp hariç ölçüdür)

Derin dondurucu kapasitesi  
Soğutucu kapasitesi  
Net iç hacim

97 lt.  
260 lt.  
357 lt.

Özellikler

**Full No Frost özelliği**  
24 saatte 12 kg dondurma kapasitesi  
Dondurucu kısmında elektronik kontrol  
"Süper Dondurucu" özelliği  
Güçlü aydınlatma

Ürününüzün nakliyesi müşterimizin evine, tarafımızdan bedelsiz olarak sağlanmaktadır.

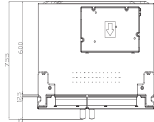
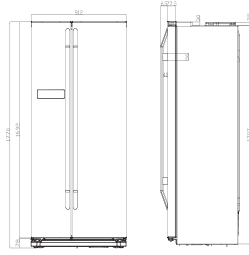

FSBS 6001 NF XS A+

Inox

118.0183.637



**Enerji sınıfı**  
**Ebat**

A+  
912x690x1770 mm  
(Kapı dahil, kulp hariç ölçüdür)

**Derin dondurucu kapasitesi**  
**Soğutucu kapasitesi**  
**Net iç hacim**

204 lt.  
373 lt.  
577 lt.

**Özellikler**

**Full No frost özelliği**  
24 saatte 16 kg dondurma kapasitesi  
Antibakteri özelliği, Cam raflar  
Elektronik kontrol  
Fresh holder özelliği  
Elektrik kesintisi halinde 4 saat koruma

Ürünümüzün nakliyesi müşterimizin evine, tarafımızdan bedelsiz olarak sağlanmaktadır.

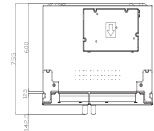
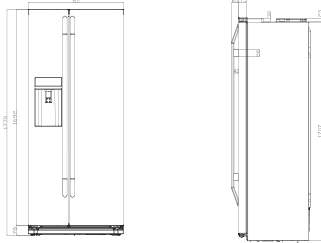

FSBS 6001 NF IWD XS A+

Inox

118.0180.391



**Enerji sınıfı**  
**Ebat**

A+  
912x690x1770 mm  
(Kapı dahil, kulp hariç ölçüdür)

**Derin dondurucu kapasitesi**  
**Soğutucu kapasitesi**  
**Net iç hacim**

175 lt.  
343 lt.  
518 lt.

**Özellikler**

**Full No frost özelliği**  
24 saatte 13 kg dondurma kapasitesi  
24 saatte 140-150 küp buz yapabilme özelliği  
Antibakteri özelliği, Su ve buz pınarı  
Elektronik kontrol, Cam raflar  
Fresh holder özelliği  
Elektrik kesintisi halinde 4 saat koruma

Ürünümüzün nakliyesi müşterimizin evine, tarafımızdan bedelsiz olarak sağlanmaktadır.

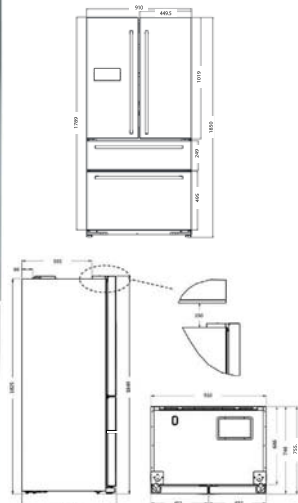

FRFD 6020 NF XS A+

Inox

118.0319.485



**Enerji sınıfı**  
**Ebat**

A+  
910x763x1850 mm  
(Kapı dahil, kulp hariç ölçüdür)

**Derin dondurucu kapasitesi**  
**Soğutucu kapasitesi**  
**Net iç hacim**

167 lt.  
362 lt.  
529 lt.

**Özellikler**

**Full No frost özelliği**  
Elektronik kontrol  
Dondurucu bölüm Nofrost özelliği  
24 saatte 18 kg dondurma kapasitesi  
Antibakteri özelliği  
Cam raflar  
Geniş kullanımlı ara bölmesiz üst dolap  
Elektrik kesintisi halinde 24 saat koruma

Ürünümüzün nakliyesi müşterimizin evine, tarafımızdan bedelsiz olarak sağlanmaktadır.





# ÇÖP ÖĞÜTÜCÜLER & AKSESUARLAR

ÇÖP ÖĞÜTÜCÜLER	254
MİNİ SORTER	255
ANKASTRE ÇÖP KOVASI	255
TEMİZLİK KİTİ	255
ÇELİK KREMİ	255
SIVI SABUNLUK	255

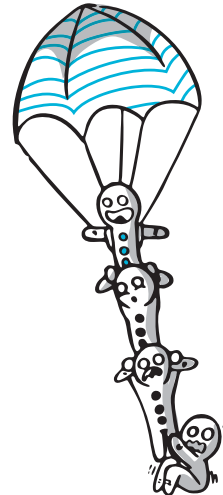

# ÇÖP ÖĞÜTÜCÜLER

Franke, zengin evye modelleri ve kullanışlı armatürlerinin yanında, çekirdek aileler için 1/2 beygir gücündeki WD 50, kalabalık aileler için de 3/4 beygir gücündeki WD 75 çöp öğütücü modelleriyle de mutfaklardaki en büyük yardımcınız.

## Çöp Öğütücüsü Nasıl Kullanılır?

- Soğuk su açılır.
- Çöp öğütücüsü çalıştırılır.
- Uygun evsel atıklar, soğuk su akarken çöp öğütücüsüne atılır.
- Öğütme işlemi bittiğinde, çöp öğütücüsü yarım dakika daha çalıştırılır ve soğuk su akıtılır.
- Öğütücü durdurulur ve yarım dakika daha soğuk su akıtılmaya devam edilir. Böylece tüm öğütülmüş atıklar, akan suyun yardımı ile atık su giderinden tahliye edilir.

**Çöp öğütücüsüne; tüm meyve sebze, narenciye ve yemek atıkları atılabilir, Metal, cam, kağıt, plastik, porselen malzemeler ile küllü su ve boru temizleme kimyasalları atılamaz.**

**Çöp öğütücünüzün temizlenmesi için;**

**Bir miktar buzla çöp öğütücüsünü boş çalıştırabilirsiniz. Ayrıca parçalara bölünmüş bir limonu da çöp öğütücüsüne atarak taze ve temiz koku vermesini sağlayabilirsiniz.**

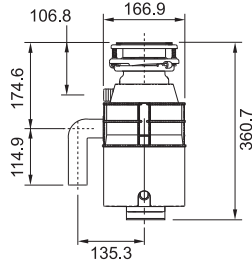

**WD 50**

**134.0253.918**

Güç 400 W  
1/2 Beygir gücü  
Kesme haznesinde gürültü önleyici özelliği  
Ağırlık 4.65 Kg.  
Yabancı madde atılması halinde otomatik durma özelliği

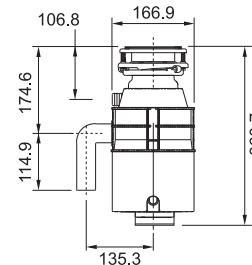

**WD 75**

**134.0253.920**

Güç 650 W  
3/4 Beygir gücü  
Tüm çöp öğütücüsünde gürültü önleyici özelliği  
Ağırlık 4.65 Kg.  
Yabancı madde atılması halinde otomatik durma özelliği

## Aksesuarlar



**Alto**

**Krom**

**133.0253.922**

Pnömatik düğme  
Tezgah üstü uygulamalar içindir.





# YÜZEY UYGULAMALARI



Make  
it  
Wonderful







# FRANKE YÜZEY UYGULAMALARI

## FRANKE SOLID SURFACE

KULLANIM ALANLARI	260
ÖZELLİKLER	261
RENK SEÇENEKLERİ	262-263
EVIYELER	264
ALIN DETAYLARI	264
SERTİFİKALAR	265

## FRANKE STONE BY LAPITEC

SERTİFİKALAR	266
ÖZELLİKLER	267
YÜZEY ALTERNATİFLERİ	268-269
RENK SEÇENEKLERİ	270-271

# Franke Solid Surface

Franke'nin kusursuz hizmet anlayışı ile sunulan Solid Surface doğal görünümü ile mutfak, banyo, ofis, sağlık kuruluşları, otel, cafe ve restaurant gibi pek çok profesyonel ya da dekorasyon gerektiren alanda, 54 renk seçeneği ile yüzeylere hayalleri yansıtıyor.



## Kullanım Alanları



Alışveriş Merkezi



Otel



Hastane



Cafe - Restaurant



Banyo



Dekorasyon



Mutfak



Özel Tasarım



## Ek Yeri Göstermeyen Yapı

Franke Solid Surface birkaç farklı levhadan ek yeri belli olmayacak şekilde birleştirilebilir ve bulunduğu yerin havasını değiştirir.



## Kişiyeye Özel

Yerinde, lazer sistem ile ölçü alınıp, ısı ile şekillenerek; Franke Solid Surface tezgahınız, istediğiniz renk, tasarım ve modelde tamamıyla size özel hazırlanır.



## Dayanıklı

Franke Solid Surface, doğal mineraller ve akriliğin birleşmesi ile oluşan güçlü yapısı sayesinde uzun ömürlü bir kullanım imkanı sunar. Yenilenebilir özelliği sayesinde oluşan küçük çizikler sünger ile ovularak giderilebilir.



## Renk Seçenekleri

Franke Solid Surface, tek renk, saydam renk, taneli ve karışık gibi farklı renk grupları ile 54 seçenek ve 7 Marble Look görünüm alternatifi sunar.



## Işık Geçirgen

Işık geçirgen özelliği sayesinde, ara panellerde Franke Solid Surface ile süslenebilir.



## Temizlenmesi Kolay

Islak bez ve basit temizleyiciler kullanılarak Franke Solid Surface ilk günkü parlaklığında uzun süre kullanılabilir.



## Hijyenik

Bakteri, küf ve leke oluşumuna izin vermeyen gözeneksiz yapısı ve kolay bakımı ile Franke Solid Surface tüm yüzeyler için ideal bir malzemedir.



## Isıya Dayanıklı

Franke Solid Surface, ısıya dayanıklı yüzeyi sayesinde kolay kullanım sunar.



Solid Surface

## ÖZEL TEK RENK



## TEK RENK



## TANELİ RENK



## PARÇALI RENK

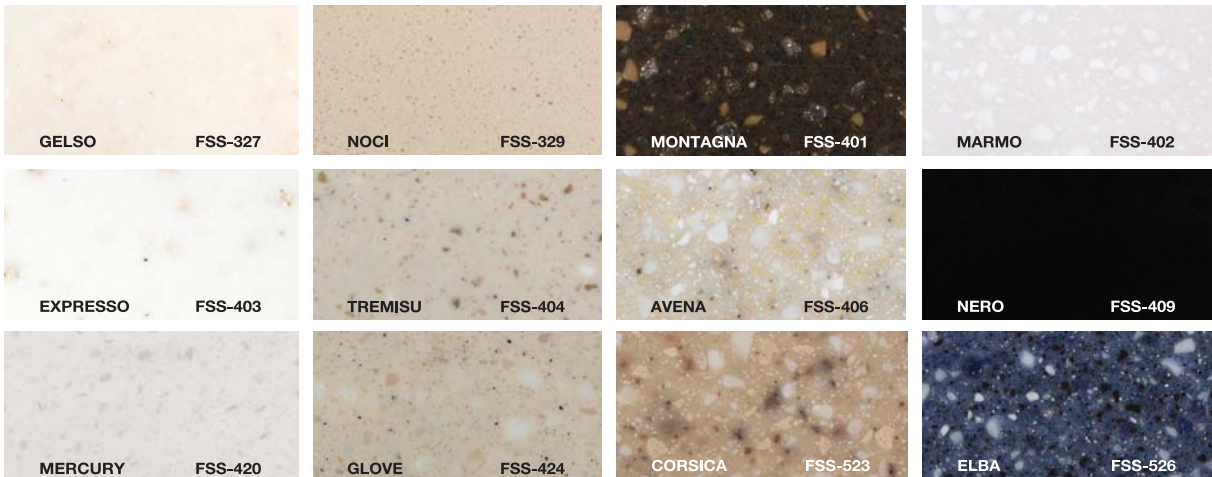

# 54 Renk Seçeneği ve Yeni Marble Collection Alternatifleri ile...

## KARIŞIK RENK

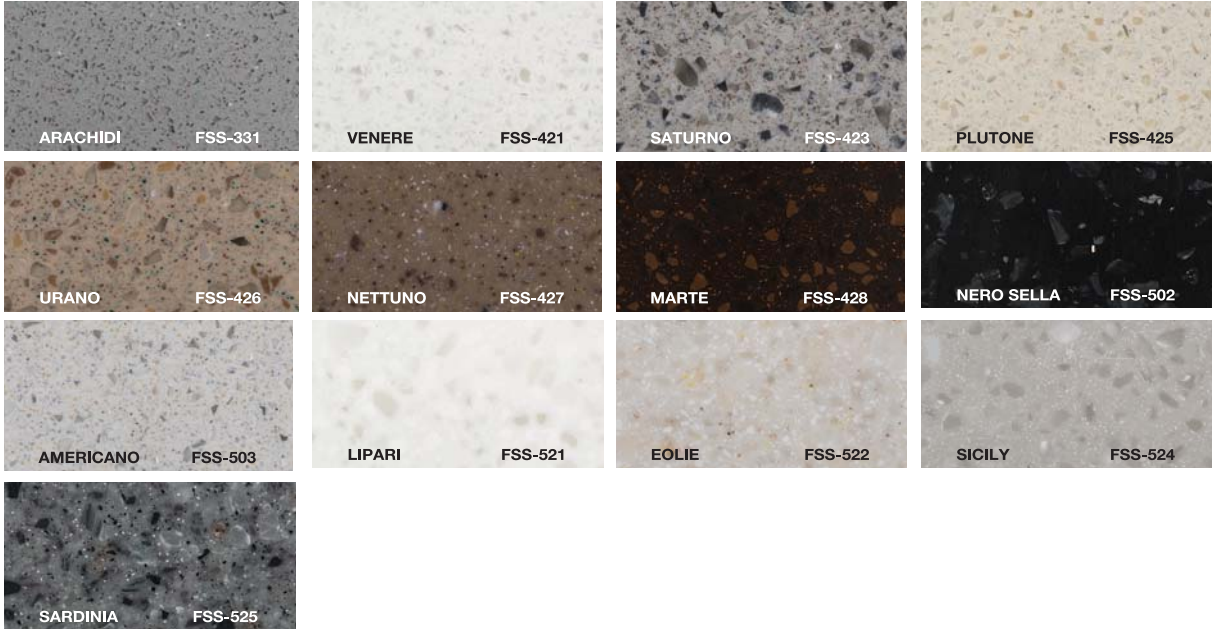

## SAYDAM TEK RENK



## <sup>YENİ</sup> Marble Collection

Franke Solid Surface şimdi 7 farklı Marble Collection alternatifi çeren koleksiyonu ile kişisel ve profesyonel tüm mekanlarda yeni bir görünüm, yeni bir tasarım sunuyor.

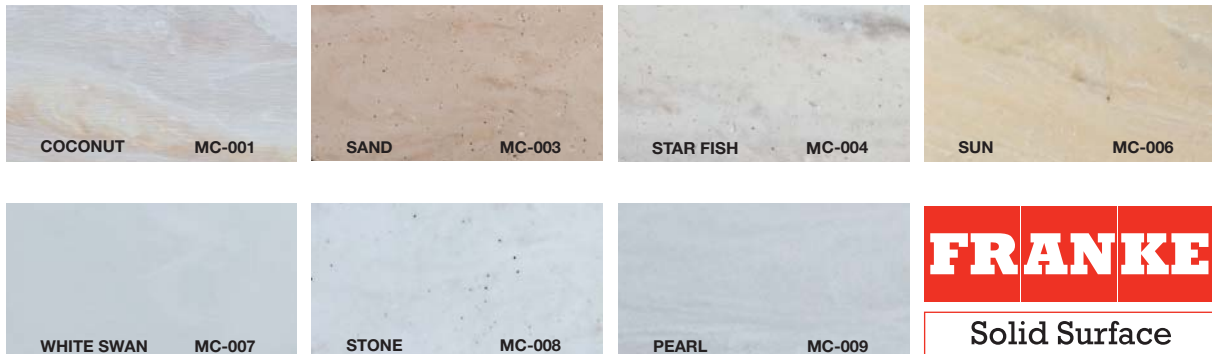



## Solid Surface Mutfak Eviyeleri

KS 110-455

Beyaz

113.0325.151



Ebat: 455 x 455 x 225 mm  
Tezgah Kesim Ebatları: 395 x 395 x 206 mm

Bağlantı elemanları dahildir. Kutudan çıkmaktadır.

## Solid Surface Mutfak Eviyeleri

KS 160

Beyaz

113.0325.152



Ebat: 740 x 455 x 225 mm  
Tezgah Kesim Ebatları: 685 x 395 x 205 mm

Bağlantı elemanları dahildir. Kutudan çıkmaktadır.

## Solid Surface Banyo Lavabosu

BS 110

Beyaz

113.0325.153



Ebat: 505 x 410 x 180 mm  
Tezgah Kesim Ebatları: 462 x 370 x 150 mm

Bağlantı elemanları dahildir. Kutudan çıkmaktadır.

## ALIN DETAYLARI

## Seçenekler



### Standart



A-11



A-12



A-13

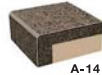

A-14

### Özel



A-21



A-22



A-23



A-24



A-25

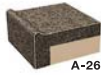

A-26



A-27



A-28



A-29



A-30



A-31



A-32

Franke, eviye, armatür, ankastre ocak, fırın, aspiratör, davlumbaz, mikrodalga fırın, buharlı pişirici, kombi fırın, bulaşık makinesi, ankastre ve solo buzdolapları, çamaşır makinesi ile mutfaklarınızda tamamladığı sistem anlayışını Solid Surface ile birleştiriyor.

Franke Çelik banyo malzemeleri ve banyo armatürleri ile de uyumlu Franke Solid Surface, tasarımlarınıza sınırsız seçenekler sunan ideal bir malzemedir.





Sağlıklı, güvenilir ve rahatlıkla kullanılacak mutfak ve banyo tasarımları.



İnsan sağlığına duyarlı malzeme



Kore akreditasyon kurulu kalite sertifikası



Çevre dostu üretim tesisi sahip firma.



Uluslararası sağlık kuruluşu tarafından gıda ile temasında herhangi bir risk teşkil etmediği onaylanmıştır.



İnsan sağlığına duyarlı ve sürdürülebilirlik kalitesine uygun akrilik malzeme.



Supervise Gözetme Etüd Kontrol Servisleri kurulunun akrilik yüzey malzemeleri dayanıklılık testi



Greenguard Çevre Enstitüsü insan sağlığı ve çevre kalite standartlarına uygun üretim tesisi.

İtalyan tarzının kusursuz bir örneği olan Franke Stone by Lapitec yüzey uygulama malzemesi estetik cazibesini %100 doğallığın zerafeti ve göze hitap eden renk ve farklı doku alternatifleri ile buluşturur.



Doğal taş kullanımına teşvik etmek, taş işçiliği standartlarını belirlemek ve taş ürünlerinin kullanımına uygun uygulamalar tasarlanmaktadır.



Uluslararası sağlık kuruluşu tarafından malzemenin gıda ile temasında bir risk teşkil etmediği beyan edilmiştir.



Doğal Mutfak ve Banyo kuruluşu uzmanlık belgesi

**%100 Doğal**

Çevreye ve insan sağlığına duyarlı olarak üretilen **FRANKE Stone by Lapitec** reçine ve petrol içermektedir.

**XXL**

3365 x 1500 mm ölçülerinde plakalar halinde ve 20 mm kalınlığı ile üretilmektedir. Her plakası 5,05 m<sup>2</sup> dir.

**Hijyenik**

Gözeneksiz bir yapıya sahiptir. Lekelere, küfe ve bakterilere dayanıklıdır. Bu gözeneksiz yapısı sayesinde yüzeyi sadece ılık bir su ve bez ile kolayca temizlenir.

**Ton farksız**

Zamana meydan okuyan güçlü bir yapıya sahiptir. Yıllar geçse dahi, aynı renk ürün talebinde ton farklılıklarının yaşanmayacağını garanti eder.

**Uzun ömürlü**

Uzun ömürlü ve suya dayanıklı bir üründür. Asitlere, boyalara, alkaliye, derin aşınmaya, yangına, yüksek ısıya, donmaya dayanıklı olup UV ışınlarından etkilenmez. Renkler ilk günkü canlılığını korur ve solmaz.

**Çizilmelere dayanıklı**

Tasarımcıların ihtiyaç duyduğu ölçülere sahip olan **FRANKE Stone by Lapitec** çizilmelere karşı dayanıklılığı ile yapı ve döşeme için en uygun çözümleri sunar.

**Bio-Care**

Bio-Care teknolojisi ile yüzeylerde biriken bakteri etkisi yaratacak parçacıkları kendi kendine temizleme özelliğine sahiptir.

**Düşük genleşme oranı**

İç ve dış yüzey kaplamalarında ortam sıcaklığı değişkenlik gösterse bile **FRANKE Stone by Lapitec** ilk günkü formunu korur. Pürüzsüz yüzey hissi ve görünümü sunar.

**Çok yönlü**

“Güçlü” yapısı sayesinde iç ve dış mekan kaplamalarından kaldırımlara, mutfak tezgahlarından havalandırma cephelelerine kadar çok sayıda alanda uygulanabilir.

# 7 farklı kullanım - 7 farklı yüzey

## Renk Seçenekleri

Artico, Bianco Polare, Bianco Crema, Avorio, Sahara, Tabacco, Porfido Rosso, Moca, Ebano, Grigio Cimento, Grigio Piombo, Nero Antracite

## Marble Look

Arabescato Michelangelo, Arabescato Perla, Arabescato Corallo

# lux

## LUX YÜZEY: PARLAKLIK YENİDEN TANIMLANDI

"LUX" koleksiyonumuzdaki plakalar, ışığı yayan, güçlü yansıtma sağlayan parlak bir yüzeye sahiptir. "LUX" mutfak tezgahları, iç ve dış mekan kaplamaları için ideal seçimdir.

Parlaklık derecesi: >65

Lapitec marka plakaların yüzeylerinde parlaklık sağlanabilmesi için %100 doğal olan mekanik kaplama işlemi uygulanmaktadır.

## Renk Seçenekleri

Artico, Bianco Polare, Bianco Crema, Avorio, Sahara, Tabacco, Porfido Rosso, Moca, Ebano, Grigio Cimento, Grigio Piombo, Nero Antracite

## Marble Look

Arabescato Michelangelo, Arabescato Perla, Arabescato Corallo

# satın

## SATIN YÜZEY: YUMUŞAK İPEKSİ VE ZARİF

İpeksi parlaklığı sayesinde "SATIN" kolayca temizlenir. "SATIN" mutfak tezgahları, iç ve dış mekan kaplamaları ile tüm yaşam alanlarındaki zeminler için ideal çözümdür.

Parlaklık derecesi: <16

## Renk Seçenekleri

Artico, Bianco Polare, Bianco Crema, Avorio, Sahara, Tabacco, Porfido Rosso, Moca, Ebano, Grigio Cimento, Grigio Piombo, Nero Antracite

# vesuvio

## VESUVIO YÜZEY: VOLKANİK MAGMANIN GÜCÜ VE CANLILIĞI

Kayma önleyici özellikler taşıyan pürüzsüz ince dokulu bir yüzeydir. "VESUVIO" hem iç hem de dış mekan kaplamaları ile tüm yaşam alanlarındaki zeminler için ideal çözümdür.

Sürtünme katsayısı: R10  
Parlaklık derecesi: <5

## Renk Seçenekleri

Artico, Bianco Polare, Bianco Crema, Avorio, Sahara, Tabacco, Porfido Rosso, Moca, Ebano, Grigio Cimento, Grigio Piombo, Nero Antracite

# dune

## DUNE YÜZEY: YUMUŞAK VE DOĞAL RENK TİTREŞİMLERİ

"DUNE" rüzgarın çevreyi nazik bir şekilde biçimlendirdiği çöllerdeki kumları anımsatır. Yumuşaktır ve her ışık demetiyle yeni renk titreşimleri keşfedilebilir. Görsel açıdan doğal olarak kırılmış taşı anımsatır, kayrak taşına çok benzer: mutfak tezgahları ve duvar kaplamaları için modern ve şık çözüm sunar.

Sürtünme katsayısı: R10  
Parlaklık derecesi: <5

FRANKE Stone by Lapitec mimarların ve tasarımcıların hayallerini gerçeğe dönüştürebilecek teknik açıdan her uygulamaya yönelik yüzey alternatifleri sunar.

## LITHOS YÜZEY: PARMAK UÇLARINIZDAKİ KADİFE

Yumuşak ve doğal renklere sahip hafif kırışıklık hissi yaratan yüzeyi ile dokunuşa yeni hisler katar. "LITHOS" çok yönlüdür, kadifemsi bir yapıya sahiptir ve zariftir: mutfak tezgahları, yatlardaki ve havuzlardaki dış yürüyüş alanları için mükemmel seçimdir.

Sürtünme katsayısı: R10  
Parlaklık derecesi: <5

## ARENA YÜZEY: İLGİ ODAĞI KUM CAZİBESİ

"ARENA" tüm plakaya doğal bir hareketlilik kazandıran tanecikli yapıya sahip pürüzsüz ve kumu andıran bir yüzeydir. Sinterlenmiş taşın bu şekilde işlenmesi renklerin daha açık görünmesini, renklerdeki canlılığın dikkat çekmesini sağlar. "ARENA" kendisini en çok dış mekan uygulamalarında gösterir.

Sürtünme katsayısı: R12  
Parlaklık derecesi: <5

## FOSSIL YÜZEY: ZAMANA MEYDAN OKUYAN MALZEME

Yüzeyi dokuludur; pürüzlü yapısı bölünmüş veya yüzeyi yakılmış doğal taş benzer. "FOSSIL" hem iç hem de dış mekan kaplamaları ile kaymayı önleyici zemin çözümleri için ideal seçimdir.

Sürtünme katsayısı: R13  
Parlaklık derecesi: <5

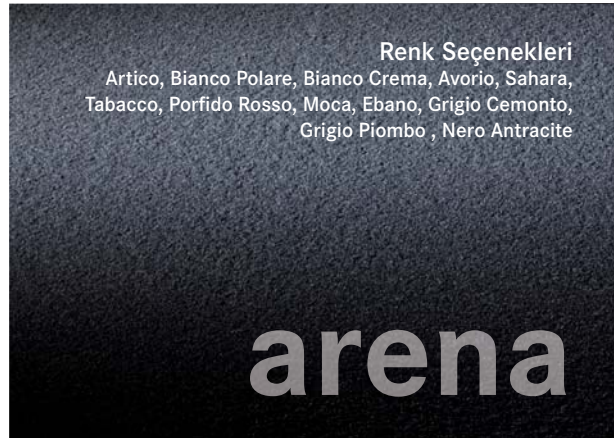

# yapısal ve biçimsel özgürlük



TÜM YÜZEY ALTERNATİFLERİNDE MEVCUTTUR.

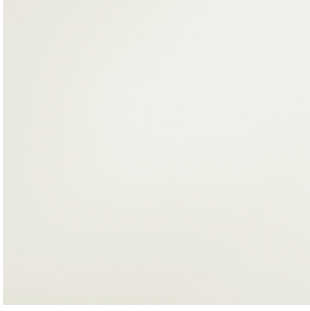

ARTICO

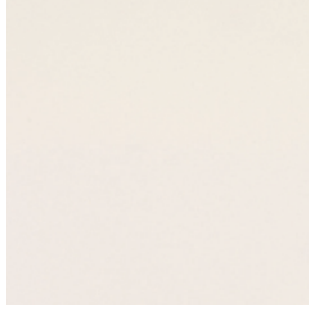

BIANCO POLARE

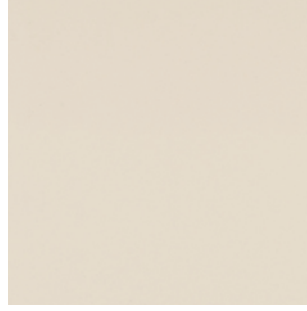

BIANCO GREMA



AVORIO



SAHARA



TABACCO



PORFIDO ROSSO



MOCA

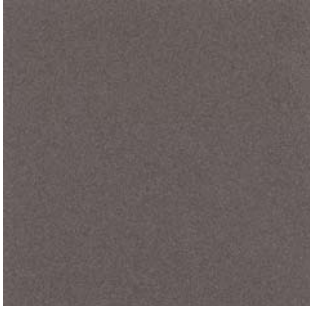

EBANO



GRIGIO CEMENTO

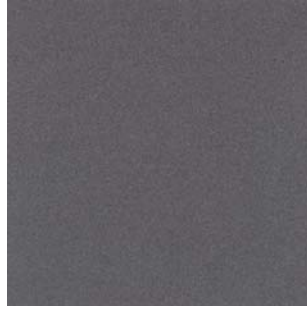

GRIGIO PIOMBO



NERO ANTRACITE

## Marble Look



ARABESCATO PERLA



ARABESCATO MICHELANGELO



ARABESCATO CORALLO

## Garanti Süresi;

FRANKE Stone by Lapitec, malzeme ve üretim kaynaklı durumlarda 10 yıl garanti kapsamındadır. Kullanım ve müşteri kaynaklı tüm durumlar garanti harici değerlendirilir.

## Kullanım Alanları

- Yüzey kaplama
- Banyo
- Mutfak
- Havuz
- Zemin
- Şömine
- Duvar kaplamaları
- Merdivenler
- Bina kaplamaları
- Raf ve çekmeceler
- Sauna - kaplıca



# TÜKETİCİ MEMNUNİYETİ ÖDÜLLÜ SERVİS AĞI

Müşteri memnuniyetini ilke edinen  
hızlı ve güvenilir hizmet  
Franke Servis ile evinize geliyor.



Detaylar için Franke yetkili servisleri ile iletişime geçebilirsiniz.



## 3 kez Müşteri Memnuniyetini İlke Edinen Firma Ödülü Franke'nin

Her zaman çizgi üstü ürün ve hizmet felsefesi ile çalışan Franke, 2010 yılında T.C. Sanayi ve Ticaret Bakanlığı, 2011 yılında Gümrük ve Ticaret Bakanlığı ve 2013 yılında Sanayi ve Ticaret Bakanlığı tarafından verilen "Müşteri Memnuniyetini ilke Edinen Firma Ödülü'nü" 3 kez kazanarak satış sonrası servis örgütünü de bu paralelde eğitmiş ve müşteri memnuniyetine öncelik vermiştir.

- Türkiye genelinde 117 teknik servis ve 35 tavsiye edilen eviye servisi ile kolay ulaşım
- Teknik eğitimli uzman VIP teknisyenler
- Service Online ile hızlı problem çözümü
- Montaj aşamasında galoş kullanımı
- Detaylı ürün Kullanımı bilgilendirmesi
- Donanımlı servis araçları
- Hızlı randevu
- Müşteri memnuniyeti anketi
- Geçici ürün hizmeti





## EVİYELER

Ürünlerimizin özelliklerine ait ikonlar, ürün ile ilgili tüm detayları okumanızda size yardımcı olacaktır.

### Sıvı sabun / deterjanlık



Bu özel aksesuar sıvı sabun ya da sıvı bulgacı deterjanınızın her an elinizin altında olmasını sağlar.

### Çöp öğütücüsüne uygun gider



Bu işareti gördüğünüz eyve modelleri çöp öğütücüsüne takılmaya uygundur.

### Döner başlı sifon kumandası



Elinizi hiç islatmadan hazne içine su doldurabilir, yada dolan suyu boşaltabilirsiniz. Kırmızı çerçeve ile belirtildiğinde opsiyoneldir.

### Pop-up sifon kumandası



Tipki döner başlı sifon kumandası gibi, gidere dokunmadan haznedeki suyu boşaltmasını sağlar. Üstelik bunun için Pop-up kısmını çekmek yeterlidir.

### Tezgah uygulama alternatifleri



Tezgaha "O" ve tezgah üstü olmak üzere iki şekilde de montajı yapılabilmektedir.



Tezgah üstü uygulama



Tezgah altı uygulama

### Aksesuar dahil modeller



Yanında bu işareti gördüğünüz aksesuarlar ilgili modele dahil, komple set olarak sunulmuştur.

### Eviyeye monte sızdırmazlık contası



Eviyenize üretim anında monte edilen bu sızdırmazlık contası hem montaj aşamasında kolaylık sağlar, hemde montaj sonrası estetiği korur.

### Şablon



Montaj ölçüsü için şablon ürün kutusundadır.

### Köşe eviye



Köşe eviye açısı 90°

### Çift yönlü eviye



Sağ ya da sol damlalık olarak çift yönlü kullanılabilir.

### Damlalıktan taşma



Süzülmesi için damlalığa koyduğunuz bulaşıklardan gelen suyun hızla tahliyesi için damlalığa yerleştirilmiş bu özel gider sistemi kullanımda maksimum fayda sağlar.



AISI 304 Çelik Kalitesi

## OCAKLAR

### Emniyet Ventili



Taşma, rüzgar vb gibi nedenlerle ateşin sönmeye halinde gazı keserek güvenli kullanım sağlar.

### Opsiyonel Düğme Kiti



Modele bağlı olarak bu sembolün yer aldığı ocaklara tavsiye edilen düğme kitleri opsiyonel olarak satın alınabilir.

### Dual Power



Konsentrik iki çember sayesinde alevi ihtiyacınıza göre ayarlanabilir. Üstelik isterseniz sadece iç çemberi isterseniz sadece dış çemberi yakabilirsiniz.

### Entegre Otomatik Ateşleme



Franke ankastre ocakları yakmak için düğmeyi çevirmek yeterlidir. Dışardan ateşle yakılmasına gerek kalmaz.

### Döküm Izgaralar



Dayanıklılık ve sağlamlık garantisi ile dökme demir ızgaralar kullanılarak aynı zamanda ocaga estetik ve profesyonel bir görüntü katılır.

### Çift taç



İç içe geçmiş iki halkadan oluşan ocak gözü, iki alev çemberi ile hızlı pişirme ve ısıtma gibi işlemlerde avantaj sağlar.

### Derin Pişirme Alanı



Ocak bekleri ile zemin arasında bulunan derinlik sayesinde taşma sonucu etraf kirlenmez. Verimli ısı dağılımı gerçekleşir.

### Tuş Kilidi



Özellikle çocuklar için güvenli sunan sistem tek bir hareket ile kumanda panelini kilitlet.

### Sliding Touch Kontrol



Elektrikli ocakın kumanda panelinde bulunan hassas dokunmatik tuşlar üzerinde sadece sağa sola parmak hareketleri ile sıcaklık gibi ayarlamalar yapılır.

### Flex Zone



Geniş tek bir alan veya daha küçük kısımlara alan bölünen Flex zone ocak gözü farklı boyutları tencere kullanımına imkan verir. Kaplar bu alan üzerinde nereye konulursa konulsun alan aktif olacaktır.

### Göz Sayısı



Ocakta bulunan göz sayısını ifade etmektedir.

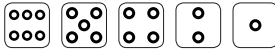

## FIRINLAR

### Konvansiyonel pişirme



Isıtma işlemi hem üst, hem de alt rezistansla yapılır. Tek tepside yemeklerinizin eşit dağılımı olarak pişirilmesini sağlar.

### Cool Door Özelliği



Çıkarılabilir fırın kapağı 3 camlı olarak tasarlanmıştır. İç kabin ısısını, fırın kapı yüzüne yansımaları minimuma indirmiştir.

### Multifonksiyonel



Franke fırın gamında yer alan birçok fırın da bu özellik bulunmaktadır.

### Enerji sınıfı



Franke fırınların tamamı geliştirildikleri yüksek teknolojiye paralel olarak enerji tasarrufu konusunda oldukça başarılıdır.

### Yavaş pişirme



Azaltılmış ısı sıcaklık ve daha az güçte et pişirme için gidaların organoleptik özelliklerini koruyarak, biraz daha uzun sürelerde pişirir.

### Fan yardımcı pişirme



Üst rezistans (tavan), alt rezistans (taban) ve fırın içi fanı devreye girer ve bir önceki fonksiyona (statik pişirme) oranla, fanında etkisiyle sıcaklığın daha eşit dağılımı elde edilerek aynı anda iki tepsi birden pişirmek mümkün olur.

### Gril (ızgara) pişirme



Fırının üst tarafında yer alan grill (ızgara) rezistansı devreye girer. Bu durumda kızıl ötesi ışınlarla yüzey kısımların hızlı bir şekilde pişmesi, etlerin iç kısımlarının yumuşak kalmasını sağlar; aynı zamanda 9 dilime kadar ekmeği tost etmek için de grill (ızgara) pişirme fonksiyonunu kullanmak mümkündür.

### Fanlı Grill (Izgara) Pişirme



Fırının üst tarafındaki grill (ızgara) rezistansı devreye girer ve fan da çalışmaya başlar. Et ve sebzelerle yapılan pişirmede, sos-sucuk türlerinde, kuru pizolalarında, bazı tavuk ve bıldırcın yemeklerinde bazı grill (ızgara) fonksiyonları ile çok iyi neticeler alınabilir.

### Hızlı pişirme



DCT fırınlar Booster programdır. Yüksek sıcaklıklara, kısa sürede ulaşılır. Ön ısıtma ve geleneksel pişirme için idealdir.

### Fanlı pişirme



Dairesel ısıtıcı eleman devreye girer ve fan çalışmaya başlar. Sabit ve eşit dağılımlı sıcak hava, yemeği her noktasında pişirir ve kızartır. Pişirme sıcaklıkları benzer olan birbirinden farklı yemek türlerini aynı anda pişirmeniz mümkün olur. Tatlılarla hamur işlerinin pişirmesi için ideal olur, aynı anda üç tepside pişirme yapılmasına imkan tanır.

### "Master chef" ile pişirme



Termostat düğmesi 50°C ile Maks. (260°C) sıcaklıklar arasında ayarlanabilir. Böylece, dairesele, alt (taban) ve üst (tavan) rezistans kısmen devreye girer. Havalandırmaya fanı yardımıyla sıcaklığın homojen şekilde dağılması, her türlü pizzanın mükemmel bir şekilde pişmesini sağlar.

### Soft Cooking



Dairesel ve üst (tavan) rezistans kısmen devreye girer. Düşük güç ve fanın etkisi, hassas ve eşit dağılımlı bir pişirme yapılmasını sağlar. Kuru pastalar ve düşük sıcaklıkta uzun süreli yapılan pişirme işlemlerinin tümü için idealdir.

### Multicooking



Aynı anda 4 tepsi yemeği birarada pişirmek için özel program.

### "Quick cooking" pizza pişirme



Dairesel rezistans, tavan - taban rezistanslar ve fanla birlikte devreye girer. Sıcaklığın dağılımı aşağıya öncelik verilecek şekilde tasarlanmıştır; bu şekilde pizzaların ya da genel anlamda dondurulmuş gıdaların hızlı şekilde hazırlanması için idealdir.

### Üst Rezistans



Sadece Üst ısıtıcı çalışır. Sıcak hava üstten kazana yayılarak üst kısmın pişmesini sağlar.

### Taban Rezistans



Isıtma işlemi aşağıdan (alt rezistans) yapılır. 50 °C ile 250 °C arasında istenilen sıcaklığı seçiniz. Bu tip pişirme çok yavaş pişirme veya yemeklerin ısıtılması açısından kullanıma uygundur.

### Barbekü



Et, tost ve hamburger gibi küçük kesimler için önerilir.

### Fan ve Lamba



Önceden pişirme yapmış fırında, pişen yemeğin soğumasını engellemek için kullanılabilir.

### Cook Book



Kullanım klavuzunda bulabileceğiniz pek çok yemek için uygun pişirme derecesi, süresi ve uygun raf bilgilerini veren Cook Book özelliği, kumanda panelinden ulaşılabilen yemek listesi sayesinde en mükemmel sofraları kurabilirsiniz.

### Fanlı alt Rezistans



Üst rezistans ve fanın aynı anda çalıştığı bu kombinasyon sayesinde yemeklerin üzeri nazikçe kızarır. Özellikle lazanya ve pasta gibi hamurlu yiyecekler için idealdir.

### Hassas pişirme



Daha düşük güç ve daha uzun süreleri ile tarifleri geniş bir yelpazede hazırlamak için mükemmeldir. Doğal pişirme için idealdir.

### Dairesel ısıtıcı ve fan



Fırında pişirme ve kızartma için uygundur. İsinin hava akımı ile hemen ulaşması nedeniyle ısı ayarını "Alt ve Üst ısıtıcı" programına göre daha düşük tutunuz.

### Pyrolitik Temizleme Özelliği



500 °C ısıda 4 cam korumasıyla 1 saat 45 dakika süresince yapılan çevrimle fırın içinde kalanyemek yağları ve tortular külleşip fırının alt haznesine düşer ve işlem sonrası nemli bir bezle kılınarak temizlenmesi çok pratiktir. Pyrolitik fırınlarda, pyrolitik temizleme esasından farklı olarak otomatik olarak kilitlenir.

### Heatpin



Isı ölçer çubuk ile yiyeceklerinizin mükemmel ısıya ulaşmadığını kontrol edebilirsiniz.

### Hamur mayalama



Tatlılar, Sufle, pizza, ekmeğin hamuru, vb için ideal hamur kabartma programı

### Fan



Önceden pişirme yapmış fırında, pişen yemeğin soğumasını engellemek için kullanılabilir.

### Buharlı temizleme



Fırın içerisinde oluşacak buhar sayesinde yumuşayan kirlerin temizlenmesini sağlar. Tepsiyi yarım lt. su konur ve alt rafa yerleştirilir.

### Şiş Özelliği



Isıtılmış fırında ürüne ait şişe yerleştirilmiş, et/tavuk vs. nin fırın içerisinde şişirilmesi için uygun şekilde tasarlanmıştır. Daha homojen pişirilmesi sağlanır.

### Kolay pişirme



Aşçı profesyonelliğinde çok çeşitli gıdaların hazırlanmasında idealdir.

### "Multy power" fanlı pişirme



Dairesel rezistans devreye girer ve buna üst rezistans (tavan), alt rezistans (taban) ile fan da kısmen eşlik ederler. Sıcaklığın daha hızlı ve güçlü şekilde enişir; sıcaklığın aynı zamanda daha eşit dağılımı sayesinde bu fonksiyon, 3 katın da kullanılabilirliği pişirmeler yapılmasına imkan sağlar.

### Sağlıklı pişirme



100 °C'de ve daha uzun sürede sağlıklı pişirme alternatifi.

### Soğutma Fanı



Franke fırınlar soğutma fanı ile donatılmıştır. Böylece fırın yan kapağı yüzeyleri soğuk tutulur.

### Sıcak yemek



Isıtma ve sıcak tutma için idealdir.

### Buz Çözme işlemi



Düğme ( ) pozisyonu üzerine, termostat düğmesi de "0" pozisyonuna getirilerek buz çözme işlemi devreye sokulur.

## DAVLUMBAZLAR

### Hız kademesi



3 Hz  
4 Hz

### Uzaktan kumanda



Modele bağlı olarak davlumbazınızı yerinizden hiç kalkmaksızın kumanda edebileceksiniz.

### Intensive timer



3+  
4+

Davlumbazınız o anda kullandığınız hızdan daha güçlü bir çekim gücü ile 10 dakika çalışarak yoğun koku veya buhanı çekecek, 10 dakikadan sonrada önceki hıza geri dönecektir.

### Filtre değiştirme hafızası



Modele bağlı olarak davlumbazınız devamlı yapıp sönen led ile alüminyum filtreleri yıkama/değiştirme uyarısı verir. Böylece her an en verimli filtreyi kullanabilirsiniz.

### 24 Saat fonksiyonu



24 fonksiyonu sayesinde davlumbazınız, mekan havasının devamlı temizliği için gün boyunca her saat 10 dakika 100 m<sup>3</sup>/h çekim gücünde çalışarak temiz hava gegmesini korur.

### Çelik Kaset Filtre



Davlumbazın daha sessiz çalışmasını sağlar.

### Opsiyonel filtre



Bu işareti gördüğünüz tüm modellerde bacasız ortamlarda davlumbaz yada aspiratörünüz opsiyonel filtre temini ile rahatlıkla kullanılabilir.

### Comfort Light



Davlumbazın aydınlatmasını hassas şekilde ayarlanmasını sağlar

### Auto-Stop programı



Davlumbazınızın mutfaga geri dönmeye gerek kalmadan kendiliğinden kapanmasını sağlayan auto-stop programını seçerek hem zamandan, hem enerjiden tasarruf edersiniz.

### Sessiz çalışma



Davlumbazın sessiz çalışması sayesinde mutfagın huzurlu bir ortama dönüşür.

### Brushless Motor



Standart motora göre %85'e varan enerji tasarrufu

MAKE IT  
Wonderful!

 [www.franke.com.tr](http://www.franke.com.tr)

 [facebook.com/franketr](https://facebook.com/franketr)

 [instagram.com/franke\\_tr](https://instagram.com/franke_tr)

 [youtube.com/Franke Türkiye](https://youtube.com/Franke_Turkiye)

## FRANKE TÜRKİYE

### FRANKE MERKEZ - Gebze

Gebze Organize Sanayi Bölgesi Tembelova Alanı  
3500. Sokak, No. 3503 Gebze / Kocaeli  
Tel: 0262 644 65 95 - Faks: 0262 644 65 85  
info.ftk@franke.com

### FRANKE FABRİKA - Manisa

Manisa Muradiye Karayolu 7. km.  
Muradiye - Manisa  
Tel: 0236 226 24 00 - Faks: 0236 246 84 56

### FRANKE INFO CENTER - Kozyatağı

Atatürk Cad., No:15 Sahrayıcedid - İstanbul  
Tel: 0216 386 07 06 - Faks: 0216 386 10 23

**FRANKE**